

International FireStop

Handbook





Dear Partners,

Construction fire prevention plays a crucial role in case of fire, which is why the fischer Group of Companies has developed the fischer FireStop range. The wide range of passive fire protection products helps to reduce the spread of fire, smoke and toxic gasses while protecting the lives of occupants as well as the infrastructure. The development of the product range is the result of over 70 years of experience in the construction industry and suggestions which arose from close cooperation with customers and other industry experts. The systems have been tested to both European and international standards, with many achieving European Technical Approval (ETA) as well as Underwriters Laboratories (UL) certification.

The broad FireStop range comprises particularly easy to install solutions for effective fire protection in all relevant fields of application in modern construction projects. These include facade applications for curtain walls and rainscreen cladding, service penetrations and solutions for linear gap sealing.

With its numerous services fischer also provides support throughout all construction phases – from consultations, layout design and training to on-site installation support. fischer is therefore a reliable partner for passive fire protection for all those involved in the project.

This international FireStop catalogue serves as your guide for construction fire protection. Intuitively find the right solutions and the most suitable sealing systems for simple and more complex applications. The updated catalogue features a clear overview of the latest products, installation graphics, calculation tables and an index for approvals and testing.

We hope you enjoy discovering and using our products.



Marc-Sven Mengis
CEO of the fischer Group of Companies

Service		1
Good reasons to choose fischer	6-7	
Basic knowledge FireStop	8-9	
Standards and certifications	10	
Advanced product selection guide	11	
FireStop in practice	12-13	
Products		2
Intumescent Acoustic Mastic FiAM	14-15	
Intumescent Acoustic Mastic FiAM US	16-17	
Fire Rated Silicone Sealant FFRS	18-19	
Rapid Fire Seal RFS 640	20-21	
Fire Barr ElastoSeal FFB-ES	22-23	
Universal FireStopping Sealant UFS 310	24-25	
Intumescent Graphite Mastic FIGM	26-27	
Foam Barrier System PLUS	28-29	
Intumescent Pipe Wrap FIPW	30-31	
Intumescent Wrap Strip FiWS	32-33	
Fire Collar FFC	34-35	
Cast in Device FCID	36-37	
Intumescent Pillows FIP	38-39	
Intumescent Putty Pad FiPP	40-41	
Coated Panel System FCPS	42-43	
FireStop Compound FFSC	44-45	
VentiStop Cavity Barrier FFB VS	46-47	
Cavity FireStop Clad FCFCl	48-49	
FireStop Foam	50-51	
Thermal Defense Wrap TDW	52-53	
Cable Coating FCC	54-55	
Tools and accessories	56	
Additional information		3
Sprinkler systems	58-59	
Fireproof mounting	60-61	
Fixings guide	58-69	
Calculation of consumption guide	70-71	
Training certification	72	
Engineering judgement request form	73	



A brand and its promise to perform

Whoever chooses fischer receives more than a range of safe products. The aim is to always develop the best solutions for our customers across the globe.

Besides the innovative products, this predominantly concerns support that is focused on the customer, and services designed to improve customer benefit.

With the fischer ProcessSystem (fPS), we ensure that we are adapting and optimising our processes in line with customer requirements in a flexible manner and on a continuous basis.

Always with its finger on the pulse of the times

At fischer, innovation is more than just a sum of the patents. We are open to new things and are prepared for change – always with the aim of offering our customers the greatest possible benefits. Over the years, our own development and production sites have been developing numerous fixing solutions for the most wide-ranging applications.

Be it new production procedures or materials, such as renewable raw materials: We are carrying out the research for your safety and will continue to do so in the future. This gives us such great flexibility that we can even develop tailor-made customer solutions. This power to innovate has seen fischer become market leader in anchor technology and the fixing industry.

Safety that connects – Decisive quality

We don't make any compromises when it comes to the safety of our products. A whole host of our products are distinguished by comprehensive, up-to-date and international approvals. The fischer product range is well-positioned in all sectors of fixing technology –

Steel, Nylon and Chemical fixings. In award-winning quality which continues to impress both professional clients and private customers with equal measure.





We take responsibility

Our active environment management policy means that we are helping to maintain an intact environment for our generation and for those that follow. The environment management policy at the Tumlingen site has been certified in line with DIN EN ISO 14001. We are a member of the German Sustainable Building Council (DGNB), and our products have been successively certified in line with the guidelines provided by the Institute for Construction and the Environment (IBU). With our greenline products, we have introduced the first fixing assortment in the market, based on over 50% of regrowing raw materials.



Institut Bauen
und Umwelt e.V.



Our service to you

We are a reliable partner, one that will stand at your side and address your individual requirements with advice and action:

- Our products range from chemical systems to steel anchors through to plastic anchors.
- Competence and innovation through own research, development and production.
- Global presence and active sales service in over 100 countries.
- Qualified technical consulting for economical and compliant fastening solutions. Also on-site at the construction site requested.
- Training sessions, some with accreditation, at your premises or at the fischer ACADEMY.
- Design and construction software for demanding applications.

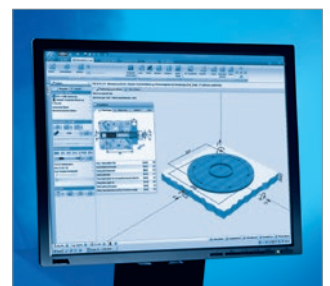
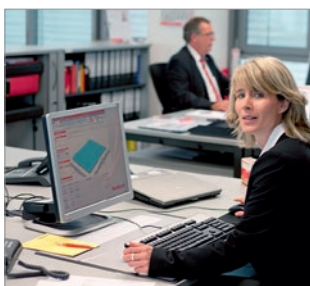

Fire prevention

Fire prevention is a critical consideration for those who are responsible for creating the design, specification and construction of new buildings, with consideration in the ongoing maintenance of occupied premises.

As the causes of fire vary and are often unpredictable, construction measures are being designed to influence the formation and spread of fire, smoke and toxic gases, by minimising the available factors needed to create a fire or to limit the spread of fire once it has started. Effective fire fighting within a building is generally achieved through a combination of active and passive FireStop systems and, when used in conjunction with each other, provide a balanced fire protection strategy.

Active FireStop systems

Active fire prevention systems are designed to react to the outbreak of a fire, which is then suppressed with the help of sprinkler systems, halogen installations, fire extinguishers or other proactive mechanical systems. The effects of the fire may also be lessened by the removal of smoke from the equation. By including alarms and emergency lighting, active systems also serve to provide escape paths for people inside the building.

Passive fire prevention systems

Passive fire prevention is an integral component, which is designed and built in to the fabric of the structure. It is also an essential element of the fire safety of a building. The risk of fire can be minimised by dividing the building into a series of compartment/cells bounded by fire rated walls and floors.

To maintain the firestopping integrity of a compartment/cells, any gaps, openings, void or channels within the fire rated walls or floors must be sealed with an approved or certified system to prevent the passage of fire, smoke and toxic gases.

Building codes and national regulations

Most model building codes have very clear requirements on passive fire protection.

"Fire investigation reports have consistently shown that unprotected or improperly protected penetrations and joints cause millions in property damage and contribute to the loss of life and injuries due to the uncontrolled migration of fire, smoke and toxic gases." In order to promote life safety and property protection, the national building codes include fire testing and performance requirements for penetration firestop and fire resistive joint systems.

The following regulations are published as statutory instruments by Parliament with respect to life safety purposes:

ENGLAND AND WALES: 1991

Section 11.2 of Approved Document B3 states: "If a fire separating element is to be effective, then every joint, or imperfection of fit, or opening to allow services to pass through the element, should be adequately protected by sealing or fire stopping so that the fire resistance of the element is not impaired"

Section 11.12 adds, under the heading of 'Fire stopping', a requirement that: "Joints between fire separating elements should be fire stopped; and all openings for pipes, ducts, conduits or cables to pass through any part of a fire separating element should be:

Kept as few in number as possible and kept as small as practical fire-stopped (which in the case of a pipe or duct, should allow for thermal movement)"

BS 7671: 2008: UNITED KINGDOM

The 17th edition of the IEE Wiring Regulations (BS 7671:2008) is the national standard in the United Kingdom for all commercial, domestic and industrial wiring installations.

Section: 527-02-01 states "Where a wiring system passes through elements of building construction such as floors, walls, roofs, ceilings, partitions or cavity barriers the openings remaining after passage of the wiring systems shall be sealed according to the degree of fire resistance required of the element concerned."

Section: 527-02-02 states "where a wiring system such as conduit, cable ducting, cable trunking, busbar or busbar trunking penetrates an element of building construction having specified fire resistance it shall be internally sealed so as to maintain the degree of fire resistance of the respective element as well as being externally sealed to maintain the required fire resistance."

GERMANY: FEDERAL STATE BUILDING ORDER

In Germany, the Federal State Building Order is regulated at the level of the federal states. Therefore, there are 16 regional state building codes with their own regulations and guidelines. The 2002 Directive Building Code and the 2005 Directive Guidelines for conduit and ventilation systems form the basis for further consideration. The list of the Technical Building Regulations – M-ETB, includes other codes, such as the MLAR and the German Ventilation Systems Directive – MLüAR. Once guidelines are adopted into the list at regional state level List of Technical Building Regulations–LTB, the guidelines become legally binding.

NFPA 101 LIFE SAFETY CODE: UNITED STATES

Life Safety Code addresses those construction, protection, and occupancy features necessary to minimise danger to life from the effects of fire, including smoke, heat, and toxic gases created during a fire. The Code establishes minimum criteria for the designs of egress facilities, so as to allow prompt escape of occupants from buildings or, where desirable, into safe areas within buildings. The Code also addresses protective features and systems, building services, operating features, maintenance activities, and other provisions in recognition of the fact that achieving an acceptable degree of life safety depends on additional safeguards to provide adequate egress time or protection for people exposed to fire. Relevant firestop requirements can be found in below mentioned references:

- 8.2.2 Compartmentation Continuity
- 8.2.3.2.4 Penetrations and Openings In Fire barriers
- 8.2.4.4 Penetrations and Openings In Smoke Partitions
- 8.3.2 Continuity of Smoke Barriers

NFPA 5000 BUILDING CONSTRUCTION AND SAFETY CODE

NFPA 5000 – Building Construction and Safety Code is a model building code developed by the National Fire Protection Association. For the most part, the requirements for fire stops are the same in NFPA 5000 as they are in the IBC. It also addresses joints between assemblies in a similar manner to the IBC. NFPA 5000 states openings must be protected by „a system or material capable of restricting the transfer of smoke“. It addresses protection for through-penetrations and membrane penetrations in Section 8.8 using the same test methods as the IBC. The requirements for F and T ratings are also the same. Joint systems, including perimeter joints at curtain walls, are addressed in the same manner as the IBC.

IBC INTERNATIONAL BUILDING CODE: UNITED STATES

In the Past: The Regional Model codes developed by the Building Officials Code Administrators International (BOCA) were used on the East Coast and throughout the Midwest of the United States, while the codes from the Southern Building Code Congress International (SBCCI) were used in the Southeast and the codes published by the International

Conference of Building Officials (ICBO) covered the West Coast and across to most of the Midwest. After three years of extensive research and development, the first edition of the International Building Code was published in 1997.

The code was patterned on three legacy codes previously developed by the organizations (BOCA, SBCCI, ICBO) that constitute IBC. By the year 2000, ICC had completed the International Codes series. Relevant firestop requirements can be found in below mentioned references:

- 702 Definitions
- 704.9 Separation of Vertical Openings - Sprinkler Exception
- 708 Fire Partitions 1 Hour Rating
- 709 Smoke Barriers 1 Hour Rating
- 710 Horizontal Assemblies
- 711 Penetrations (General)
- 711.3.2 Sprinkler Heads Electrical Boxes
- 711.4.1.2 „F“ & „T“ Rating Requirements
- 712 Fire-Resistant Joint Systems
- 712.4 Curtain Wall to Edge of Slab

OTHER RELEVANT CODES FROM IBC: UNITED STATES

The International Building Code and International Residential Code are just a few of the comprehensive I-Codes the Code Council has created. The publications of the codes allow for easier following from members and allow them to observe and study the model code. Some of these codes have specific practices, such as the International Fire Code and the International Green Construction Code, or the IGCC. Here is the current list of I-Codes developed and published by the Code Council:

- International Building Code
- International Residential Code
- International Fire Code
- International Plumbing Code
- International Mechanical Code
- International Fuel Gas Code
- International Energy Conservation Code
- IBC Performance Code
- International Wildland Urban Interface Code
- International Existing Building Code
- International Property Maintenance Code
- International Private Sewage Disposal Code
- International Zoning Code
- International Green Construction Code

OTHER RELEVANT CODE

NFPA is responsible for 300 codes and standards that are designed to minimize the risk and effects of fire by establishing criteria for building, processing, design, service, and installation.

Some of the other widely used NFPA codes are:

- NFPA 70 NEC – National Electrical Code
- NFPA 96 - Standard for Ventilation Control and Fire Protection of Commercial Cooking Operations.
- NFPA 221 - Standard for High Challenge Fire Walls, Fire Walls, and Fire Barrier Walls

Approvals, markings and their importance

British Standard
BS 476-20

BS 476-20:1987
Fire tests on building materials and structures. Method for determination of the fire resistance of elements of construction (general principles).

BS EN13501-1

EN13501-1:2007+A1:2009
Fire classification of construction products and building elements. Reaction to Fire.

BS EN13501-2

EN13501-2:2007+A1:2009
Fire classification of construction products and building elements. Resistance to Fire.

BS EN1366-3: 2004

EN1366-3:2004
Fire resistance tests for service installations - Penetration seals.

BS EN1366-4: 2006

EN1366-4:2006
Fire resistance tests for service installations - Linear joint seals.

DIN

DIN 4102:Part1
Fire behaviour of building material and elements - Part 1: Building materials, concepts.

American Standard
ASTM E 84 (UL 723)

ASTM E 84
Test method for Surface Burning Characteristics of Building materials. The test evaluates the spread of flame along the surface of the material. It is not a resistance test.

American Standard
ASTM E 1966 (UL 2079)

ASTM E 1966
Test method for Fire-Resistive Joint Systems. This test is used to evaluate the performance of a joint after a cyclic movement test and fire exposure test. UL 2079 - equivalent.

American Standard
ASTM E 814 (UL 1479)

ASTM E 814
Test method for Fire Tests of Through Penetrations Fire Stops. This test is used to evaluate the performance of a firestop system, following fire exposure a hose stream test is conducted. UL 1479 - equivalent.

BS EN ISO 10140

BS EN ISO 10140:2010
The laboratory measurement of airborne sound insulation of building elements.

BS EN 1026

BS EN 1026: 2000
Air permeability test method.

BS EN 1027

BS EN 1027: 2000
Water permeability test method.



CE marking is a declaration by the manufacturer (through verified testing) that the product meets all the appropriate provisions of the relevant legislations implementing certain European Directives. ETA - The European Technical Assessment provides information about the construction product to be declared in relation to its essential characteristics.



UL is an abbreviation for Underwriters Laboratories Inc. which is an independent, not for profit product safety testing and certification organisation.



UL-EU Mark is intended for use on products destined for the European marketplace.



FM Approvals is an international leader in third-party certification and approval of commercial and industrial products.



Certifire is an independent Third Party Certification organisation. The scheme undertakes requirements such as the manufacturing of products under a Third Party Quality Management System, Independent Audit Testing, and a Comprehensive Field of Applications document based on careful chosen test that helps to ensure the products and systems are used within their approval scope.



Product	Tested to							Approved to				Application							Page		
	ES 476: Part 20	ES EN 1366-3	ES EN 1366-4	DIN 4102	AS 1530	ASTME 814 (UL 1479)	ASTME 1966 (UL 2079)	ASTME 84 (UL 723)	ETA/CE marking	UL approved	Certifire approved	FM approval	Construction joint	Perimeter joints	Metallic pipes	Insulated pipes	Non-metallic pipes	Cable and cable trays		Air ducts	Insulated air ducts
Intumescent Acoustic Mastic FiAM	■	■	■				■	■	■	■		■		■				■	■	14	
Intumescent Acoustic Mastic FiAM US	■					■	■	■	■		■	■	■	■	■	■	■	■	■	■	16
Fire Rated Silicone Sealant FFRS	■		■					■		■		■									18
Rapid Fire Seal RFS 640	■					■	■	■	■		■	■	■	■				■	■		20
Fire Barr ElastoSeal FFB-ES	■		■					■				■	■								22
Universal FireStopping Sealant UFS 310	■					■	■	■	■		■	■	■	■	■	■	■	■	■	■	24
Intumescent Graphite Mastic FiGM	■	■	■					■		■		■		■	■	■	■	■	■	■	26
Foam Barrier System PLUS		■				■		■	■												28
Intumescent Pipe Wrap FiPW	■	■						■		■					■	■					30
Intumescent Wrap Strip FiWS						■	■	■	■		■			■	■	■					32
Fire Collar FFC	■	■						■							■	■					34
Cast in Device FCID	■				■											■					36
Intumescent Pillows FiP	■	■						■		■				■				■	■		38
Intumescent Putty Pad FiPP	■	■																■			40
Coated Panel System FCPS	■	■						■		■				■	■	■	■	■	■		42
FireStop Compound FFSC	■	■			■	■		■	■					■	■	■	■	■	■		44
VentiStop Cavity Barrier FFB VS	■		■									■	■								46
Cavity FireStop Clad FCFcl	■		■					■		■		■	■								48
FireStop Foam	■		■	■								■									50
Thermal Defense Wrap DTW	■	■						■						■	■		■	■	■		52



FCPS / FPC / FiAM / FFC

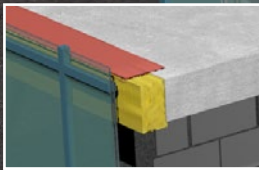

RFS 640 / FBB-ES



FireStop Foam



UFS 310 / FiAM (US) / FIGM



FiPP / UFS 310 / FIGM



FiP

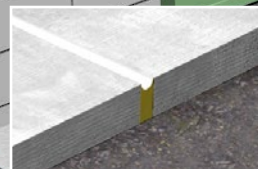

FiAM (US) / FFRS / FBB-ES / RFS 640 / FireStop Foam

FiAM (US)	Intumescent Acoustic Mastic	Page 14 / 16
FFRS	Fire Rated Silicone Sealant	Page 18
RFS 640	Rapid Fire Seal	Page 20
FBB-ES	Fire Barr ElastoSeal	Page 22

UFS 310	Universal FireStopping Sealant	Page 24
FIGM	Intumescent Graphite Mastic	Page 26
FIPW	Intumescent Pipe Wrap	Page 30
FIWS	Intumescent Wrap Strip	Page 32



FFB VS / FCFCl

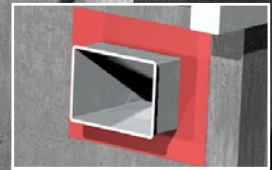

RFS 640 / UFS 310 / FIGM / FCPS

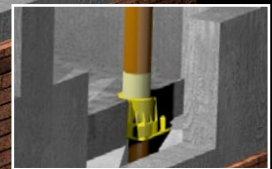

FCID



FiWS / FFC



FFSC / FCPS



RFS 640 / UFS 310 / FIGM / FCPS



FiWS / FiPW / FFSC / FiAM

FFC Fire Collar
 FCID Cast in Device
 FiP Intumescent Pillows
 FiPP Intumescent Putty Pad

Page 34
 Page 36
 Page 38
 Page 40

FCPS Coated Panel System
 FFSC FireStop Compound
 FFB VS VentiStop Cavity Barrier
 FCFCl Cavity FireStop Clad

Page 42
 Page 44
 Page 46
 Page 48

Flexible fire resistant acoustic mastic



2
Products

BUILDING MATERIALS

- Flexible wall constructions
- Rigid floor and wall constructions
- Masonry
- Concrete
- Timber
- Steel
- FCPS System

ASSESSMENT/APPROVAL



British Standard

BS 476 - 20

BS EN ISO 10140-3:1995

BS EN 1026

BS EN 1366-4

BS EN 1366-3

**ASTM E 84
(UL 723)**



Approved CF 5034



ADVANTAGES

- Water based
- Low VOC
- Movement capability $\pm 25\%$
- Excellent acoustic properties
- Approved for infinite linear gap length
- Halogen and solvent free
- Paintable and excellent slump characteristics

APPLICATIONS

- Metallic pipes: 6" (159 mm)
- Cable trays: 18" x 2" (450 x 50 mm)
- Cable bunches: 3" (80 mm)
- Linear joints: flexible and rigid construction elements
- Joints between FCPS coated panel system

FUNCTIONING

- FiAM is a one-part water-based acrylic emulsion.
- It has a fire resistance of up to 5 hours when used in construction joints and services in both vertical and horizontal applications.
- When exposed to fire, it reacts to form a highly insulative char that slows down heat transfer and provides a barrier to fire seal.
- It is suitably compatible in a variety of materials, and is utilised within the FCPS which is designed to seal large openings in fire rated floors and walls.

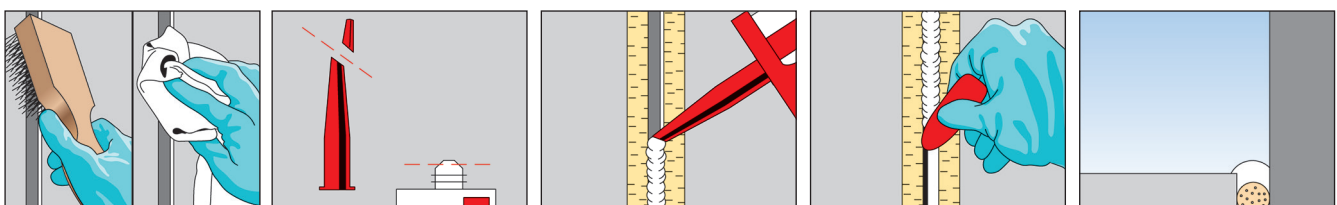

INSTALLATION

1. Clean all surfaces free from loose debris and contaminants and install required backing material.
2. Apply FiAM to required parameters as per approved system, making sure that it is in contact with all surfaces to provide maximum adhesion.
3. Tool sealant to a defect-free finish using a wetted trowel or putty knife.

SPECIFICATIONS

Item	Art.-No.	Languages on the cartridge	Contents [ml]	Suitable for use with	Sales unit [pcs]
FiAM 310	053011	DE, FR, EN, IT	310	–	25
FiAM 310	538152	DK, FI, SE, NO	310	–	25
FiAM 310	538150	TR, PT, ES, NL	310	–	25
FiAM 310	538151	PL, SK, CZ, HU	310	–	25
FiAM 600	056006	–	600	–	25
KP M2	053117	–	–	FiAM 310, FFRS 310, UFS 310, FiGM 310	1
Applicator gun 600 ml	097967	–	–	FiAM 600	1

All items are available in grey and are subject to minimum order requirement.

TECHNICAL DATA

Chemical base	Water-based acrylic
Relative gravity	Approx 1.6 g/cm ³
Skin-forming time	Approx 10 minutes at 23 °C RH
Curing rate	Approx 1.5 mm per 24 hours*
Storage temperature	+5 °C to +25 °C
Movement capability	± 25 %
Slump	Nil up to 30 mm
Shelf-life	18 months (under recommended conditions)
pH Value	8 - 9.5
Sound transmission class (Rw partition and specimen)	63 dB
Yield per l/m	Depending on application
Colour	White, grey
European Technical Approval	ETA 14-0378, ETA 14-0379
CE marking	1121-CPR-JA5044

* Curing rate is dependent on substrate, air humidity and weather conditions.

APPLICATION DATA

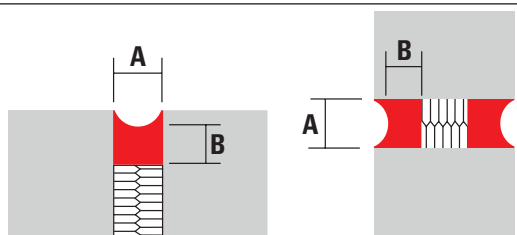
		Joint width A [mm]	Joint depth B [mm]	Yield per linear metres
		30	20	0.5
		20	15	1
		15	8	1.25
		10	10	3
		6	6	4.25

Substrate	Max. joint width [mm]	Fire ratings	
		Integrity rating [minutes]	Insulation rating [minutes]
Concrete/concrete	60	240	240
Brick/concrete	25	240	30
Steel/blockwork	50	300	90
Hardwood/blockwork	50	60	60
Softwood/blockwork	25	30	30
Drywall/concrete/head detail	20	120	120

Service type size		Fire ratings	
		Integrity rating [minutes]	Insulation rating* [minutes]
Copper/steel/metal pipes	14 - 159 mm diam.	Up to 120	Up to 90
Loaded cable tray	450 x 50 (tray) cables to 21 mm	Up to 120	Up to 90
Single/bunched cables	30 - 80 mm diam. cables	Up to 90	Up to 90

* Copper, steel and metal pipes with an insulation rating of up to 90 minutes are in conjunction with the Thermal Defense Wrap (TDW).

General purpose fire resistant sealant designed for UL specific applications

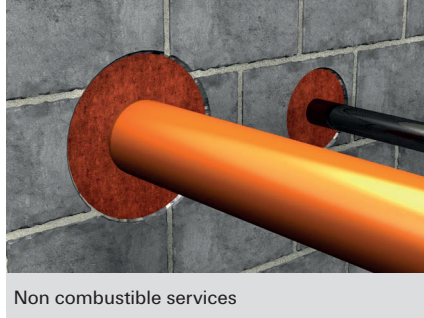

Non combustible services

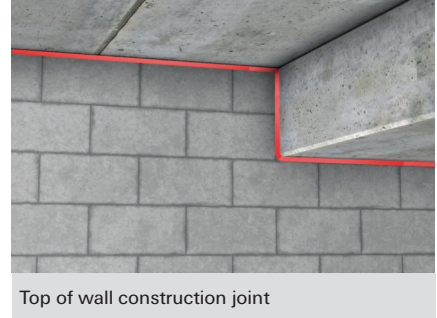

Top of wall construction joint

BUILDING MATERIALS

- Flexible wall constructions
- Rigid floor and wall constructions
- Masonry
- Concrete
- Steel

ASSESSMENT/APPROVAL



American Standard

ASTM E 814
(UL 1479)

ASTM E 84
(UL 723)

ASTM E 1966
(UL 2079)

ADVANTAGES

- Water based
- Excellent acoustic properties
- Low VOC
- Halogen and solvent free
- Various applications with two products only
- Age resistant
- Smoke resistant
- Excellent adhesion
- F-rating up to 3 hrs
- T-rating up to 3 hrs

APPLICATIONS

- Linear joints: flexible and rigid construction elements with dynamic movement
- Metallic pipes
- Insulated metallic pipes
- Conduits
- Cable and cable bunches
- Cable trays

FUNCTIONING

- The FiAM US is a one-part water based fire resistant sealant designed for a wide range of UL listed applications.
- The FiAM US can be used in construction joint and service penetration applications.
- The FiAM US can be used in both vertical and horizontal orientation and can be used in conjunction with the FiWS for a wide range of combustible services.

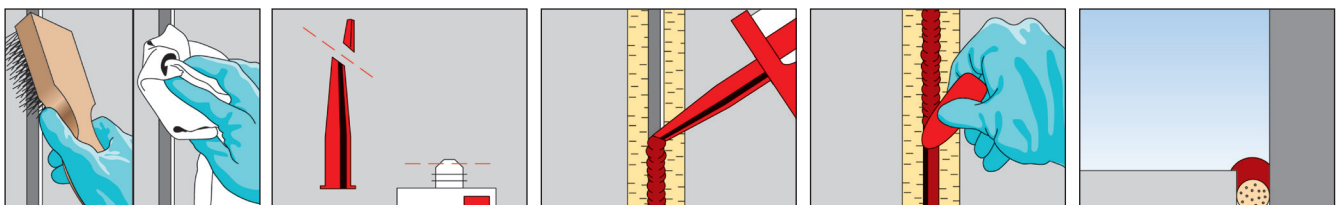

INSTALLATION

1. Clean all surfaces free from loose debris and contaminants and install required backing material.
2. Apply FiAM US to required parameters as per approved system, making sure that it is in contact with all surfaces to provide maximum adhesion.
3. Tool sealant to a defect-free finish using a wetted towel or putty knife.

SPECIFICATIONS

Item	Art.-No.	Languages on the cartridge	Contents [ml]	Suitable for use with	Sales unit [pcs]
FiAM US	546487	DE, EN, ES, TR	310	–	12
KP M2	053117	–	–	FiAM 310, FFRS 310, UFS 310, FIGM 310	1

TECHNICAL DATA

Chemical base	Water-based elastomeric
Density	12.5 +8/ 0.5 lbs.&gal.
Application temperature	4 °C - 49 °C
Skin-forming time	Approx. 20 - 30 min.
Curing rate	3 to 4 weeks at 25 °C
Storage temperature	2 °C - 49 °C
Movement capability	Up to 33%
Shelf-life	Up to 36 months (under recommended conditions)
pH Value	7-8
Sound transission class (dB) Tested in a UL 411 wall assembly to ASTM E90	65 dB (STC)
Surface burning characteristics ASTM E84 UL 723 Tunnel Test	Flame spread: 10 Smoke: 10
Colour	Red

APPLICATION DATA

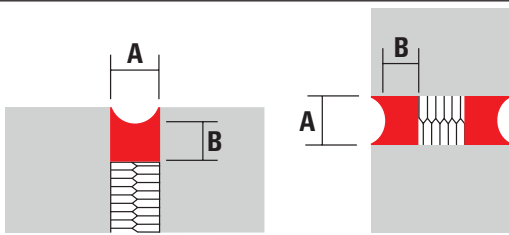
	Joint width A [mm]	Joint depth B [mm]	Linear metres per cartridge
	30	20	0.5
20	15	1	
15	8	2.6	
10	10	3	
6	10	5.1	

Elastomeric fire resistant sealant

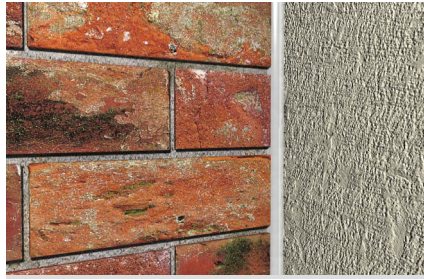

Wall to wall construction joint

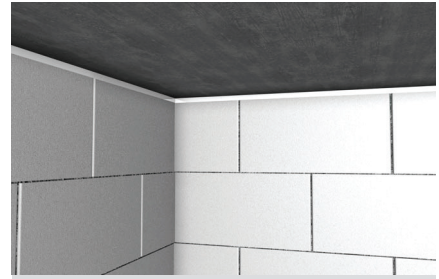

Top of wall construction joint

BUILDING MATERIALS

- Concrete
- Masonry
- Steel
- Timber

ASSESSMENT/APPROVAL



British Standard

BS 476 - 20

BS EN 1366-4

BS EN 1026

BS EN ISO 10140-3:1995

ISO 11600

ADVANTAGES

- Excellent acoustic properties
- Primerless adhesion to most substrates
- Approved for infinite linear gap length
- Halogen and solvent free
- Excellent slump characteristics
- Movement capability $\pm 25\%$

APPLICATIONS

- General construction joints in floor to floor, wall to wall, floor to wall and head of wall 2" (50 mm)
- Internal and external applications

FUNCTIONING

- FFRS is a one part silicone based sealant that can provide up to 5 hours fire resistance when used in construction joints.
- It provides primerless adhesion to a wide range of porous and non-porous substrates.

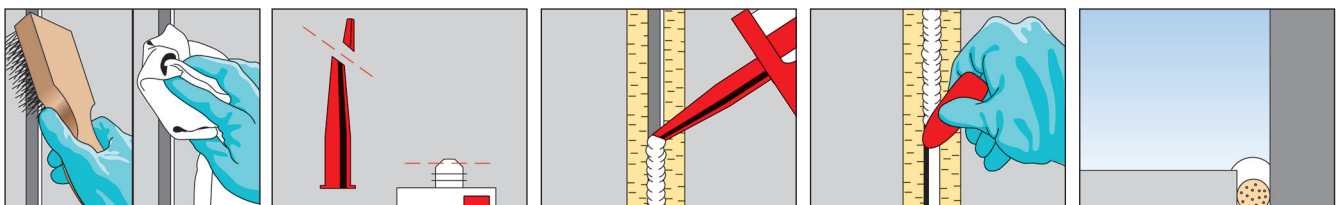

INSTALLATION

1. Clean all surfaces free from loose debris and contaminants and install required backing material.
2. Apply FFRS to required parameters as per approved system, making sure that it is in contact with all surfaces to provide maximum adhesion.
3. Tool sealant to a defect-free finish using a wetted trowel or putty knife.

SPECIFICATIONS

Item	Art.-No.	Languages on the cartridge	Contents	Suitable for use with	Sales unit
			[ml]		[pcs]
FFRS White 310 ml	512374	DE, FR, EN, IT	310	–	12
FFRS White 310 ml	538140	DK, FI, SE, NO	310	–	12
FFRS White 310 ml	538138	TR, PT, ES, NL	310	–	12
FFRS White 310 ml	538139	PL, SK, CZ, HU	310	–	12
KP M2	053117	–	–	FiAM 310, FFRS 310, UFS 310, FiGM 310	1

All items are available in grey and are subject to minimum order requirement.

TECHNICAL DATA

Cure system	Alcoxy
Relative gravity	1.17 kg/m ³
Skimming time	Approx. 5/10 minutes (at 25 °C and 50 % relative humidity)
Tack free time	Approx. 20 minutes (at 25 °C and 50 % relative humidity)
Full cure	Approx. 2 - 3 mm per 24 hours (at 25 °C and 50 % relative humidity)
Shore a hardness	16
Extrudability g/min	55 (standard NMRPS 495A 3 mm/3 bars)
Movement accommodation	± 25 %
Application temperature range	+5 °C to +40 °C
Service temperature range	Range: -50 °C to +150 °C - must not be stored above 35 °C
Shelf life	Up to 12 months when stored in unopened cartridges under cool, dry conditions
Colour	White, grey, black
European Technical Approval	ETA 15-0799
Elastic recovery	> 90 %
Slump	Nil up to 30 mm
Sound transmission class (Rw partition and specimen)	38 dB

The cured sealant is unaffected by water, dilute acids and alkalis, soap and household detergents. Certain solvents may soften and swell the cured rubber on prolonged contact.

APPLICATION DATA

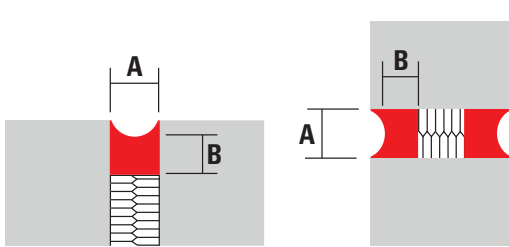
	Joint width A [mm]	Joint depth B [mm]	Yield per linear metres
		30	20
	20	15	1
	15	8	1.25
	10	10	3
	6	6	4.25

Above provides approx. yield from 1 x 310 ml cartridge

Substrate	Max. joint width [mm]	Depth of sealant [mm]	Fire ratings	
			Integrity rating [minutes]	Insulation rating [minutes]
Concrete/concrete	12	6	300	122
Concrete/concrete	30	15	300	86
Concrete/concrete	50	25	300	65
Steel/concrete	12	6	300	48
Steel/concrete	20	15	300	43
Steel/concrete	50	25	300	33
Softwood/concrete	12	6	199	5
Softwood/concrete	30	15	143	
Softwood/concrete	12	6	300	69

Rapid fire resistant sealant

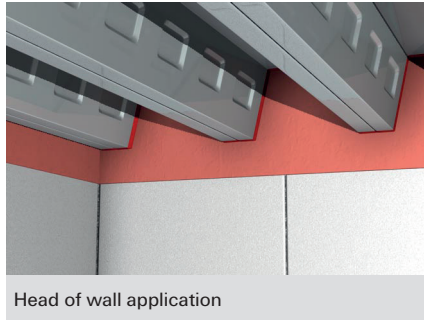

BUILDING MATERIALS

- Flexible wall constructions
- Rigid floor and wall constructions
- Flexible wall
- Masonry
- Concrete

ASSESSMENT/APPROVAL

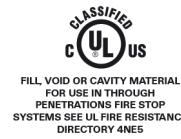

American Standard

ASTM E 814
(UL 1479)

ASTM E 84
(UL 723)

ASTM E 1966
(UL 2079)



ADVANTAGES

- Water based
- Flexible set
- Contains mould growth inhibitor
- Freeze - thaw capabilities
- Paintable
- Accelerated age and humidity tested
- Low VOC
- Spray or brush applied
- Excellent smoke seal
- Water resistant
- Asbestos and solvent free
- Can be used for internal applications and for conditions where dynamic movement may occur.

APPLICATIONS

- Curtain wall/slab edge: 8" (200 mm)
- Head of wall: 4" (100 mm)
- General construction joints: 8" (200 mm)
- Cable tray: 24" x 4" (600 mm x 100 mm)
- Steel pipes: 8" (200 mm)

FUNCTIONING

- RFS 640 is a spray grade one-part water-based, fire rated sealant, which has been designed to provide smoke and fire protection on construction joints and service penetrations in both vertical and horizontal applications.
- Provides up to 3 hours fire rating (also in accordance with ASTM E 2307).
- Meeting the new requirements of ASTM E 1399, RFS 640 has been cycled tested up to 500 times.
- Can be used for internal applications and for conditions where dynamic movement may occur.
- RFS 640 has also been tested at positive pressure with a minimum 0.01 in. (2.5 mPa) water i.a.w UL 2079 test standards.

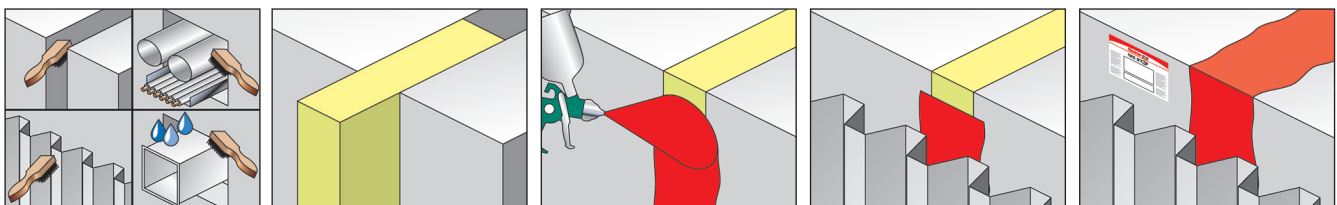

INSTALLATION

1. Clean all surfaces free from loose debris and contaminants, and install required backing material as per approved system.
2. Apply RFS 640 to the required parameters making sure that it is in contact with all surfaces to provide maximum adhesion.
3. Tool sealant to a defect-free finish using a wetted trowel or putty knife.

SPECIFICATIONS

Item	Art.-No.	Contents [l]	Sales unit [pcs]
RFS 640	516539	19	1

TECHNICAL DATA

Chemical base	Water-based
Density	Approx 1.25 g/cm ³
Application temperature	+5 °C to +40 °C
Skin-forming time at 25 °C	Approx. 30 - 45 minutes*
Curing time at 25 °C	Approx. 5 - 7 days*
Storage temperature	+2 °C to +49 °C
Movement capability	Up to 50 %**
Water resistant	Yes***
Shelf life	36 months from manufacturing (under recommended conditions)
pH Value	7 to 8
Sound transmission class (dB) Tested in a UL 411 wall assembly to ASTM E90	65 dB
Surface burning characteristics ASTM E 84 UL 723 Tunnel Test	Flame spread: 0 Smoke index: 0
Colour	Red

* Skin-forming and curing time is dependant on substrate, air humidity and weather conditions.

** Movement capability depends on UL listed system and configuration.

*** Is water resistant in accordance with UL 2079.

APPLICATION DATA

Joint width [inch]	Joint width [mm]	Ft./gallon	Ft./pail	LM/gallon	LM/pail
0.25	6	198	1,325	89	404
0.50	13	164	1,099	74	335
0.75	19	141	941	63	287
1.00	25	124	830	56	253
1.25	32	109	731	49	223
2.00	51	82	548	37	167
4.00	102	49	328	22	100
6.00	152	35	233	16	71
8.00	203	27	180	12	55

The above table provides an approx. yield for a coverage of 1/16" (1.5 mm WFT) with a 1/2" (12.5 mm) overlap.

Elastomeric fire resistant coating for construction joint and assemblies



BUILDING MATERIALS

- Flexible wall constructions
- Rigid floor and wall constructions
- Concrete
- Masonry

ASSESSMENT/APPROVAL



British Standard

BS EN 10140

BS EN 1366-4: 2006

BS EN 1026

BS EN 1027

BS 476-20

BS EN 1364-4

BS EN 1366-3



ADVANTAGES

- Openings up to 20" (500 mm) wide
- Movement capabilities of 50 %
- Working temperature between -10 °C and 95 °C
- Can be spray or brush applied
- Air permeability
- Acoustic performance
- 80 kg/m³ stone wool base
- 2.5 mm WFT required

APPLICATIONS

- Linear joints in construction elements
- Floor to floor
- Wall to wall
- Head of wall
- Bottom of wall
- Curtain wall

FUNCTIONING

- FFB-ES is a one-part water-based acrylic coating, which has been designed to provide smoke and fire protection on construction joints in both vertical and horizontal applications.
- Developed for use on 80 kg/m³ stone wool base.
- Once applied, it prevents the passage of fire and smoke and can contribute to the acoustic value of a structure between fire rated compartments giving a fire resistance for up to EI 240.

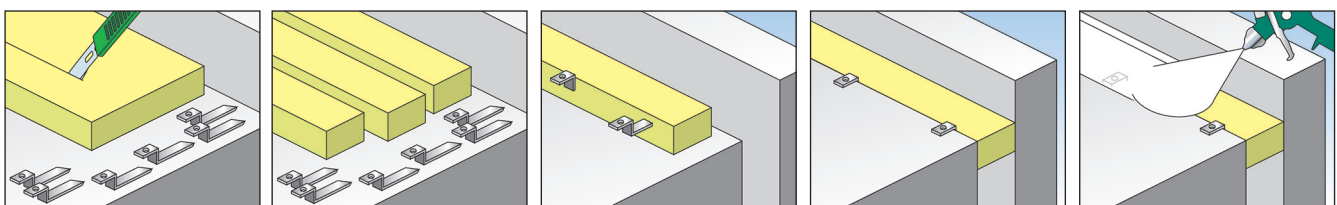

INSTALLATION

1. Use rubber gloves and eye protection to avoid skin and eye contact.
2. Cut 80 kg/m³ x 100 mm thick rock wool to suit opening. Allow a minimum of 10 mm compression or 30 % for movement joints.
3. Install Z Brackets at mid section of stone wool for openings in excess of 250 mm.
4. Compress stone wool into opening, ensuring all joints are butted tightly and surface is flush to slab.
5. Apply FFB-ES via spray, brush or trowel, to minimum 2.5 mm WFT, ensuring a minimum of 12 mm overlap to slab and rear of panel/wall.

SPECIFICATIONS

Item	Art.-No.	Content [kg]	Colour	Sales unit [pcs]
FFB-ES/White	520753	20	white	1
FFB-ES/Grey	520755	20	grey	1
FFB-ES/Red	520756	20	red	1

Quantity per box is subject to minimum order requirement.

TECHNICAL DATA

Description	Water-based, flexible acrylic coating
Colour	White = standard/grey and red to order only
Density	1.25 - 1.3 g/cm ³
Coating thickness	2.5 mm nominal, wet film thickness
Sealant coverage	2.8 kg/m ² , 2.24 l/m ²
Fire resistance	EN1366-4:2006 120 EI
Acoustic performance	43 dB when installed with one 100 mm thick 80 kg/m ³ stone wool and tested to EN10140 52 dB when installed with 200 mm thick 80 kg/m ³ stone wool and tested to EN10140
Air permeability	600 PA positive and negative pressure and tested to EN1026
Water permeability	450 PA positive pressure and tested to EN1027
Container size	20 kg
Spraying guidance	For optimum results, an airless sprayer should be utilised at a pressure of 90 psi using a spray tip of approx. 29 - 35 thou. +5 °C and +32 °C
Application temperature	For long term storage and ease of installation, it is recommended that ElastoSeal be stored indoors and in dry conditions
Storage and disposal	Storage temperature between -5 °C and +25 °C. For health and safety details, refer to fischer technical department
Shelf life	12 months from date of manufacture
European Technical Approval	ETA 15-0203
CE marking	1121-CPR-JA5065

APPLICATION DATA

Joint width [inch]	Joint width [mm]	Ft/gallon	Ft/pail	LM/gallon	LM/pail
0.25	6	119	800	54	244
0.50	13	99	683	44	202
0.75	19	85	567	38	173
1.00	25	73	492	33	150
1.25	32	66	443	30	135
2.00	51	49	328	22	100
4.00	102	31	207	14	63
6.00	152	22	148	10	45
8.00	203	16	108	7	33

The above table provides an approx. yield for a coverage of 2.5 mm Wet Film Thickness (WFT) with a 12.5 mm overlap. Figures above are approx. guide only.

Universal firestopping sealant which is suitable for metallic, non-metallic services and construction joints

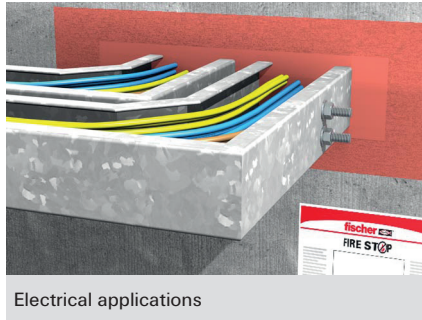

Electrical applications

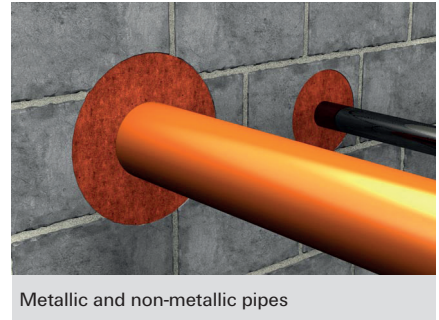

Metallic and non-metallic pipes

2
Products

BUILDING MATERIALS

- Wall constructions - linear joints
- Floor constructions - linear joints
- Flexible wall
- Masonry
- Concrete

ASSESSMENT/APPROVAL



American Standard

ASTM E 814
(UL 1479)

ASTM E 84
(UL 723)

ASTM E 1966
(UL 2079)



ADVANTAGES

- Water based
- Flexible set
- Contains mould growth inhibitor
- Freeze - thaw capabilities
- Paintable
- Accelerated age and humidity tested
- Low VOC
- Excellent acoustic properties

APPLICATIONS

- Metallic services: steel and cast iron 20" (500 mm) - copper 6" (150 mm)
- Non metallic service: PVC 2" (51 mm open) 3" (75 mm closed)
- Insulated service: 20" (500 mm)
- Construction joints: 4" (100 mm)
- HVAC 100" (2500 mm)
- Cable bunches 4" (100 mm); busway 27" (686)

FUNCTIONING

- UFS 310 is a one-part water-based intumescent sealant which is used for sealing construction joints and service penetration in both vertical and horizontal applications.
- Up to 4 hours of fire rating can be provided.
- It exhibits excellent slump characteristics, is easy to apply and cures to a flexible set. It is suitable for internal applications and conditions where dynamic movement may occur.
- UFS 310 can be used for most application properties.

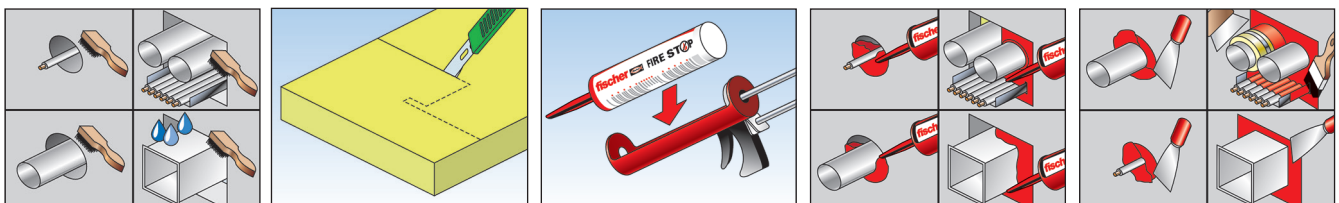

INSTALLATION

1. Clean all contact surfaces so they are free from loose debris and contaminants such as oil, dirt, grease, wax, old sealant, etc.
2. Install the required backing material as per the detailed instruction or approved system under compression.
3. Apply UFS 310 to required parameters as per detailed instruction or approved system, making sure that it is in contact with all surfaces to provide maximum adhesion.
4. Tool sealant to a defect-free finish using a wetted towel or putty knife.

SPECIFICATIONS

Item	Art.-No.	Languages on the cartridge	Contents	Contents	Suitable for use with	Sales unit
			[ml]	[l]		[pcs]
UFS 310	516538	DE, FR, EN, NL	310	–	–	12
UFS 310	538137	DK, FI, SE, NO	310	–	–	12
UFS 310	538135	TR, PT, ES, IT	310	–	–	12
UFS 310	538136	PL, SK, CZ, HU	310	–	–	12
UFS 19 liter bucket	533889	–	–	19	–	1
KP M2	053117	–	–	–	FiAM 310, FFRS 310, UFS 310, FIGM 310	1

TECHNICAL DATA

Chemical base	Water-based elastomeric
Density	Approx. 1.31 g/cm ³
Application temperature	+5 °C to +40 °C
Skin-forming time	Approx. 20 - 30 min.
Curing rate	Approx. 4 mm in 72 hours*
Storage temperature	+2 °C to +49 °C
Movement capability	Up to 50 %**
Intumescent activation	From 190 °C to 593 °C
Shelf life	Up to 36 months (under recommended conditions)
pH Value	6.5 to 7
Sound transmission class (dB) Tested in a UL 411 wall assembly to ASTM E90	62 dB
Surface burning characteristics ASTM E 84 UL 723 Tunnel Test	Flame spread: 0 Smoke index: 0
Colour	Red

* Curing rate is dependant on substrate, air humidity and weather conditions.

** Movement capability depends on UL listed system and configuration.

APPLICATION DATA

Types	Services		Fire ratings (minutes)	
	Types	Sizes	Integrated rating	Insulation rating
PVC/CPVC closed pipe systems		3" (75 mm)	120	120
PVC/CPVC open pipe systems		2" (50 mm)	120	120
Steel and cast iron pipes		20" (508 mm)	180	0
Copper pipes		6" (152 mm)	180	0
Insulated services		20" (508 mm)	120	120
Construction joints		4" (100 mm)	120	120
HVAC		100" (2,500 mm)	120	120
Cable bunches		4" (100 mm)	120	120
Cable tray/ladder		24" (600 mm)	120	45
Bus bar		27" (686 mm)	120	45

High performance intumescent graphite fire resistant mastic

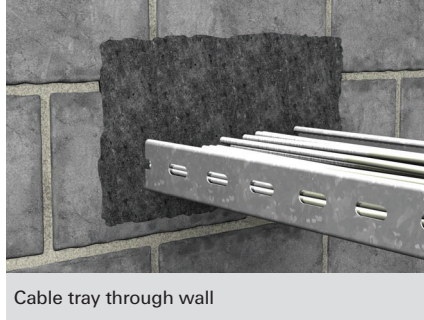

BUILDING MATERIALS

- Concrete
- Masonry
- Steel
- Timber

ASSESSMENT/APPROVAL



British Standard

BS 476 - 20

BS EN 1026

BS EN ISO 140-3:1995

BS EN 1366-3: 2004



Approved CF 5151



FBC™ System Compatible indicates that this product has been tested, and is monitored on an ongoing basis, to assure its chemical compatibility with FlowGuard Gold®, BlazeMaster® and Corzan® pipe and fittings. FBC™, FlowGuard Gold®, BlazeMaster® and Corzan® are licensed trademarks of The Lubrizol Corporation

ADVANTAGES

- Low VOC
- Excellent acoustic properties
- Halogen and solvent free
- Excellent slump characteristics

APPLICATIONS

- Metallic pipes: 6" (159 mm)
- Non-metallic pipes: 5" (125 mm)
- Cable bunches: 1" (21 mm)
- Insulated service: 6" (159 mm)
- Construction joints: 1" (25 mm)
- Mixed services

FUNCTIONING

- FiGM is a one-part water-based flexible acrylic emulsion containing a high pressure intumescent graphite, which is used to seal service penetrations in both vertical and horizontal applications.
- It can expand up to 20 times its own volume and cures to form a resilient, flexible fire seal.

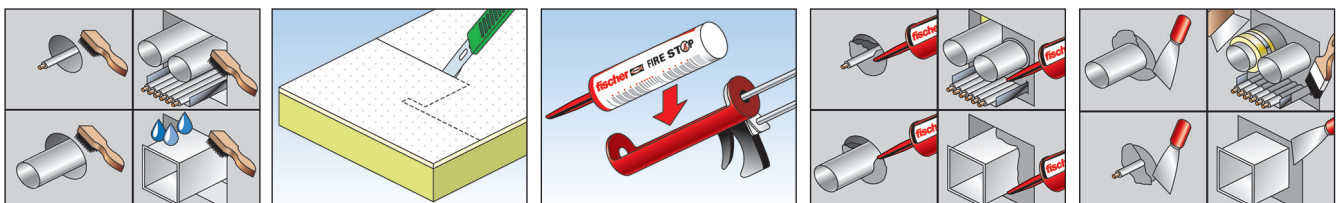

INSTALLATION

1. Clean all contact surfaces so they are free from loose debris and contaminants.
2. Install the required backing material as per the detailed instruction or approved system.
3. For best application results, FiGM should be at room temperature.
4. Apply FiGM to required parameters as per detailed instruction or approved system, making sure that it is in contact with all surfaces to provide maximum adhesion.
5. Tool sealant to a defect-free finish using a wetted towel or putty knife.
6. Clean all equipment with water immediately after use.

SPECIFICATIONS

Item	Art.-No.	Languages on the cartridge	Contents [ml]	Suitable for use with	Sales unit [pcs]
FiGM 310 ml	508765	DE, FR, EN, IT	310	–	25
FIGM 310 ml	538147	TR, PT, ES, NL	310	–	25
FiGM 310 ml	538148	PL, SK, CZ, HU	310	–	25
FiGM 310 ml	538149	DK, FI, SE, NO	310	–	25
KP M2	053117	–	–	FiAM 310, FFRS 310, UFS 310, FiGM 310	1

TECHNICAL DATA

Form	Aqueous thixotropic paste
Density	Ca. 1.3g/cm ³
Cure rate	1.7 mm per 24 hours dependent on conditions
Application temperature	+5 °C to +35 °C
Tack free	30 minutes
Cure system	Water-based
U.V. resistance	Good
Expansion onset temperature	Ca. 180 °C
Expansion	Up to 20 times
Skinning time	15 minutes at 25 °C / 50 % RH
Service temp range	Store in cool dry conditions between ±5 °C and ±25 °C
Sound transmission (Rw partition and specimen)	64 dB
Shelf life	Up to 18 months unopened
European Technical Approval	ETA 14/0381
CE marking	1121-CPR-JA5047
Chemical and water resistance	The cured sealant is unaffected by water, dilute acids and alkalis, soap and household detergents. Contains a plasticised acrylic polymer, fire retardant fillers, blowing agents and mirror additives. No component labelled as dangerous under EEC directives criteria.

APPLICATION DATA

Types	Services	Fire ratings (minutes)	
		Integrated rating	Insulation rating
PVC pipe	Up to 125 mm diam.	120	120
HDPE pipe	Up to 90 mm diam.	120	120
ABS pipe	Up to 90 mm diam.	180	120
Insulated copper pipe	Up to 60 mm diam. pipe + up to 32 mm insulation	180	120
Cables	Up to 21 mm diam. x bunches 10 max	120	120
Mixed	Up to 63 mm diam. HDPE + 21 mm diam cables x 10	120	120

Minimum wall thickness = 100 mm

FireStop Foam and FireStop Block for use in a System. Or individually. ETA approved and UL listed applications.

Products 2

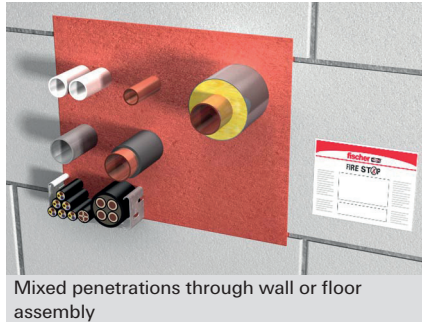

BUILDING MATERIALS

- Concrete (wall and floors)
- Masonry
- Flexible wall

ASSESSMENT/APPROVAL



EN 1366-3: 2004

American Standard

EN 13501-1

ASTM E 814
(UL 1479)

ASTM E 84
(UL 723)

ADVANTAGES

- Easy access for difficult to reach openings
- Low VOC
- Various applications with two products only
- Age resistant
- Smoke resistant
- Resistant to damp
- Re-enterable and repairable
- Excellent adhesion
- No backing material required
- F-rating / E-rating up to 2 hours
- T-rating / I-rating up to 2 hours

APPLICATIONS

- Metallic pipes up to 8 in. (203 mm)
- Insulated metallic pipes
- Conduits
- Cable and cable bunches
- Cable trays
- Mixed multiple penetrations

FUNCTIONING

- **FBS** is a two component polyurethane expanding sound, smoke and firestopping seal for hard to reach locations which expands to up to 5 times of its volume.
- **FBB** are highly elastic mouldable blocks.
- **FIB** is a glass fiber reinforced intumescent wrap to enhance the insulation value of ETA applications.
- Tested in accordance with ASTM E 814 (UL 1479), ASTM E84 (UL 723) as well as EN 1366-3, EN 13501 the Barrier System PLUS allows an easy application which saves time and costs on site.

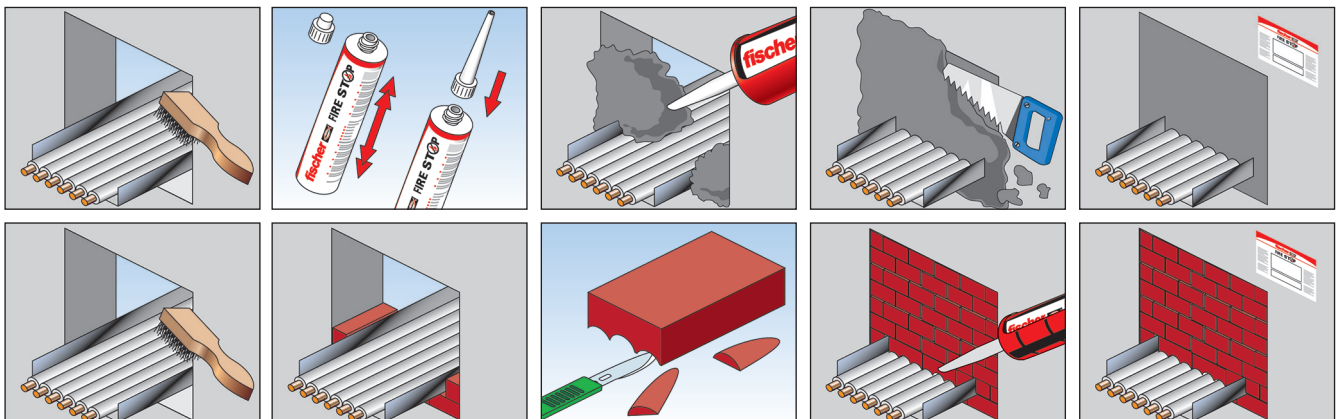

INSTALLATION

1. Clean all contact surfaces so they are free from loose debris and contaminants.
2. Install the required backing material as per the detailed instruction or approved system.
3. Unscrew cap from cartridge and insert into the dispensing gun.
4. Discard non-uniform initial material.
5. Fill the opening from back to front. Build up the foam from bottom to top.
6. After 2 minutes, tool foam to a defect-free finish using a suitable knife.
7. Cables or pipes that will be installed retroactively can be routed through the existing foam. Refill gaps due to removed cables or pipes with FBS foam.

SPECIFICATIONS

Item	Art.-No.	Languages on the cartridge	Contents [ml]	Dimensions [mm]	Sales unit [pcs]
FBS-UL	544079	–	380	–	6
FBB-UL FireStop Block	544083	–	–	200 mm x 130 mm x 60 mm	12
FBS-EN	544084	DE, FR, EN, IT	380	–	6
FBS-EN	544085	DK, FI, SE, NO	380	–	6
FBS-EN	544086	PL, SK, CZ, HU	380	–	6
FBS-EN	544087	TR, PT, ES, NL	380	–	6
FBB-EN FireStop Block	544088	–	–	200 mm x 144 mm x 60 mm	4
FIB Insulating Bandage	544089	–	–	5000 mm x 150 mm	1
FFBD Foam Barrier Dispenser	544090	–	–	–	1

TECHNICAL DATA

Criteria	FBS-UL	FBS-EN	FBB-UL	FBB-EN
Density		≥ 215 kg/m ³		240 kg/m ³ to 300 kg/m ³
Temperature resistance	≤ 80 °C	≤ 80 °C	≤ 80 °C	≤ 80 °C
Construction material class		B2 - as per DIN 4102		B2 - as per DIN 4102
Cartridge content	380 ml	380 ml		
Yield	≤ 1.9 l	≤ 2.1 l		
Cure time	Approx. 90 s	Approx. 90 s		
Colour	Red-brown	Red-brown	Red-brown	Red-brown
Pack size	Boxed in 6	Boxed in 6	Boxed in 4	Boxed in 18
Shelf life	12 months from date of manufacturing	12 months from date of manufacturing		
Storage Temperature	+5 °C to +30 °C	+5 °C to +30 °C		
Sound Transmission Class		43.5 dB - 66 dB		45.5 dB - 68 dB
Application Temp Range	+15 °C to +30 °C	+15 °C to +30 °C		

APPLICATION DATA - UL

	Blank Opening	Metallic Pipes and Conduits	Cables / Cable Trays	Insulated Metal Pipes	Mixed Penetrations
Max. possible sizes of penetrants	Max 32 in. x 32 in. (813 x 813 mm)	Max 8 in. (203 mm) diameter	Max 24 in. (610 mm) wide by max 6 in. (152 mm) deep cable tray	Max 8 in. (203 mm) diameter with 1 in. (25 mm) insulation	See listed system
Barrier System PLUS UL	C-AJ-0158, W-L-0052	C-AJ-1669	C-AJ-3341; C-AJ-4110; W-L-4091	C-AJ-5383	C-AJ-8260; C-AJ-8261

APPLICATION DATA - ETA

		Seal thickness 144 mm	Seal thickness 200 mm
Cable / Cable Trays and Ladders	Sheathed electrical cables up to 80 mm	Wall: E120 / EI60 - Floor: EI60	Wall / Floor: E120 / EI90
	Tied cable bundles up to 100mm		
	Non-sheathed electrical cables		
Conduits	Conduits / pipes of plastic up to a max. diameter of 40 mm	Wall: E120 / EI60 - Floor: E60 / EI30	Wall / Floor E120 / EI60
Pipes	Insulated metal pipes with max. diameter of 54 mm	Wall: E120 / EI90 - Floor: EI60	Wall / Floor E120 / EI90
	Non-insulated metal pipes with max. diameter of 28 mm	Wall: E120 / EI60 - Floor: EI60	Wall / Floor E120 / EI90
	Insulated metal pipes with AF/Armaflex insulation up to 88.9 mm diameter	Wall: E120 / EI90 - Floor: EI60	Wall / Floor EI120
	Combustible pipes with max. 50 mm diameter	Wall: E120 - Floor: EI60	Wall / Floor EI120

For detailed information please refer to ETA 17/0845. Remaining space around penetrants can be filled with FBB FireStop Block.

An intumescent single or endless wrap for sealing flammable pipes

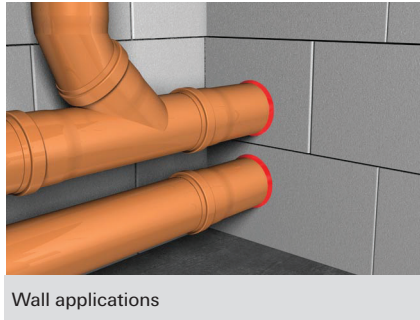

ASSESSMENT/APPROVAL



British Standard

BS 476 - 20

BS EN 1366-3



ADVANTAGES

- Efficient and effective for sealing of pipe openings in floors and walls
- Easy to fit
- Moisture resistant
- No mechanical fixing required
- Economical solution
- Up to 4 hours fire resistance
- Asbestos and halogen free
- Available on a roll for more flexibility in pipe diameters

APPLICATIONS

- Non-metallic pipes
- Polyvinyl Chloride PVC
- Chlorinated Polyvinyl Chloride cPVC
- Medium-density Polyethylene MDPE
- High-density Polyethylene HDPE
- Acrylonitrile Butadiene ABS

FUNCTIONING

- FiPW is a flexible composite strip, which is composed of thermoplastic component containing intumescent graphite in a synthetic compound and enclosed in an outer polyethylene cover.
- Can also be used as a cast-in solution. For large openings, use in conjunction with FCPS or FFSC.

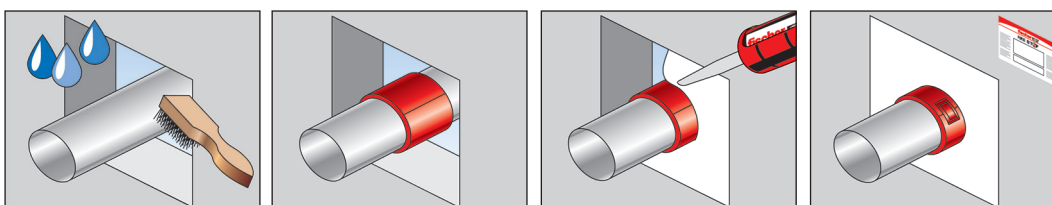

INSTALLATION

1. Clean all contact surfaces so they are free from loose debris and contaminants.
2. Ensure services are sufficiently supported as per approved system or local building codes.
3. Choose the correct size of FiPW or FiPW-E in accordance with the pipe diameter.
4. Wrap FiPW or FiPW-E around the pipe and fix tightly in required position.
5. Backfill with FiAM or FFSC as per detailed instruction or approved system.

SPECIFICATIONS

Item	Art.-No.	Fits pipe-Ø	Fire rating	Sales unit [pcs]
FiPW E / 2 mm (25 meter roll)	539608	30 - 200	2	1
FIPW 2/30-32	052546	30 - 32	2	20
FIPW 2/38-40	052547	38 - 40	2	20
FIPW 2/55	052548	55	2	20
FIPW 2/63	052560	63	2	20
FIPW 2/75	052561	75	2	20
FIPW 2/82	052562	82	2	20
FIPW 2/110	052563	110	2	20
FIPW 2/125	052890	125	2	20
FIPW 2/160	052891	160	2	20
FIPW 2/200	053000	200	2	20

TECHNICAL DATA

State	Solid
Colour	Black inner component in outer red carrier
Odour	Odourless
Density	1.3 kg/m ³
Expansion ratio	1 : 25
Significant expansion occurs at temperature	> 180 °C
Application temperature	-40 °C to 130 °C minutes
Available sizes	> 30 mm and max. up to 200 mm
Storage temperature	N/a
Shelf life	60 months
Dimensions (thickness x diameter)	4 mm up to 63 mm - 6 mm up to 110 mm - 10 mm thereafter ...; 2 mm for 25 meter roll.

APPLICATION DATA

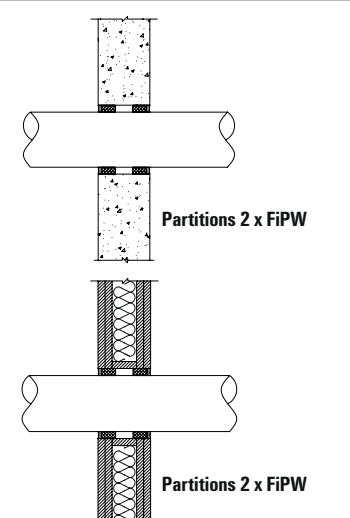
	Configuration for up to 120 min.			
	Outer pipe diam. [mm]	No. wraps	Thickness	Length (theoretically) for FiPW E [mm]
	40	1	2	126
	55	2	4	352
	63	2	4	402
	75	2	4	478
	82	2	4	521
	90	3	6	867
	110	3	6	1055
	125	4	8	1608
	160	4	8	2047
	200	5	10	3203

Universal intumescent wrap strip for sealing combustible services

Products 2

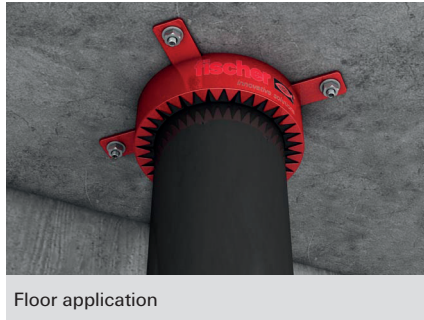

Floor application

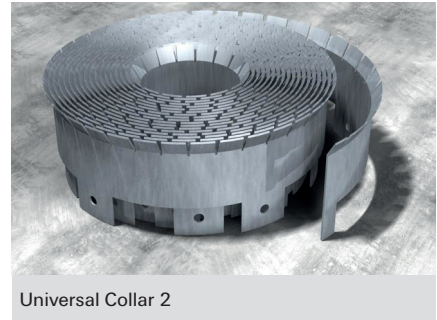

Universal Collar 2

ASSESSMENT/APPROVAL

American Standard

ASTM E 814
(UL 1479)

ASTM E 84
(UL 723)



FILL VOID OR CAVITY MATERIAL
FOR USE IN THROUGH
PENETRATIONS FIRE STOP
SYSTEMS SEE UL FIRE RESISTANCE
DIRECTORY 4NE5



APPROVED

ADVANTAGES

- Efficient and effective for sealing of pipe openings in floors and walls
- Easy to fit
- Moisture resistant
- Freeze-thaw characteristics
- No mechanical fixing required
- Economical solution
- Up to 4 hours fire resistance
- Asbestos and halogen free

APPLICATIONS

- Non-metallic service: PVC 14" (355 mm), cPVC 8" (203 mm), ABS 6" (152 mm), FRPP 4" (102 mm)
- Insulated service: Steel 10" (254 mm), Iron 10" (254 mm), Copper 4" (102 mm), Glass fibre 3" (75 mm), AB/PVC flexible foam 1" (25 mm)
- Cable bunches: 3" (76 mm)

FUNCTIONING

- FiWS is a flexible, intumescent graphite-based synthetic compound strip, which has been designed to be installed in both vertical and horizontal applications.
- FiWS has been developed as a PRE or cast-in FireStop solution, and has been designed to work with the fischer Universal Collar for retro fitting or surface mounted applications.
- For large openings, the FiWS can be used in conjunction with the FFSC.

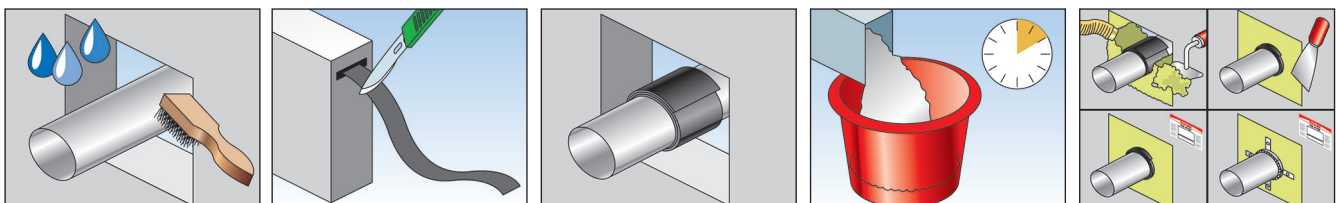

INSTALLATION

1. Clean all contact surfaces so they are free from loose debris and contaminants.
2. Ensure services are sufficiently supported as per approved system or local building codes.
3. Choose the correct size of FiWS in accordance with the pipe diameter.
4. Wrap FiWS around the pipe and fix it tightly.
5. Backfill with FiAM or FFSC as per approved system.

SPECIFICATIONS

Item	Art.-No.	Dimensions [mm / inch]	Sales unit [pcs]
FiWS-2	531397	50 mm x 6 mm x 3.66 m / 2" x 1/4" x 12'	1
Universal Collar 2	536053	51 mm x 15 m / 2" x 50 ft	1

TECHNICAL DATA

State	Solid
Colour	Black inner component in outer red carrier
Odour	Odourless
Density	1.3 kg/m ³
Expansion ratio	1 : 40
Significant expansion occurs at temperature	> 190 °C
Application temperature	-40 °C to 130 °C
Max. Pipe diameter	Max. < 355 mm (14")
Flame spread (ASTM E 84 - UL723)	5
Smoke index (ASTM E 84 - UL723)	5
Shelf life	5 years = 60 months

APPLICATION DATA

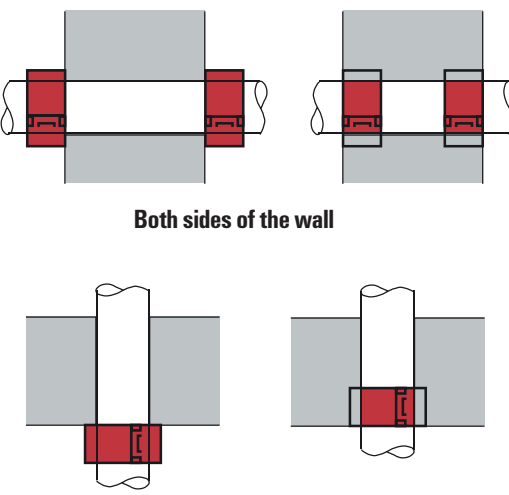
	FiWS 2 - typical configuration			Length [m]
	Pipe diameter [mm]	No. of layers	No. of stacks for 2" wraps	
 <p>Both sides of the wall</p> <p>Bottom of floor</p>	50	1	1	0,34
	75	2	1	1,1
	100	2	1	1,42
	150	3	1	3,18
	200	4	1	5,64
	305	4	2	16,56

Note: For detailed information please refer to the appropriate UL listed systems.

Collar for sealing a wide range of combustible pipes where passing through fire rated walls and floors



Floor applications

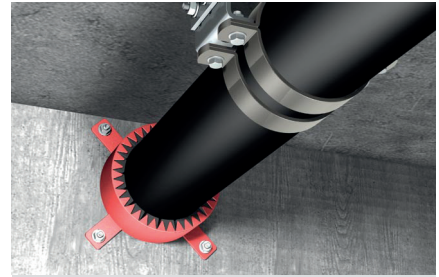

Wall applications

Products

2

BUILDING MATERIALS

- Flexible and rigid wall constructions
- Solid concrete floors
- Hollow precast floors

ASSESSMENT/APPROVAL



British Standard

BS 476 - 20

BS EN 1366-3



ADVANTAGES

- Easy retrofit at any time
- Water resistant
- No minimum annular service required
- Pre-fixed attachment lugs
- Fold back tag for secure fixture around pipe

APPLICATIONS

- Non-metallic pipes: like PVC, HDPE, MDPE, ABS of various sizes through fire rated walls and floor assemblies

FUNCTIONING

- FFC is a powder coated cylindrical steel sleeve, which contains a heat reactive graphite-based intumescent material that expands during fire.
- Designed to be securely fitted around the pipe and held in position with a retaining bolt.
- Any gaps up to 10 mm around FFC should be backfilled with FiAM or larger annular space should be closed with FCPS or FFSC.

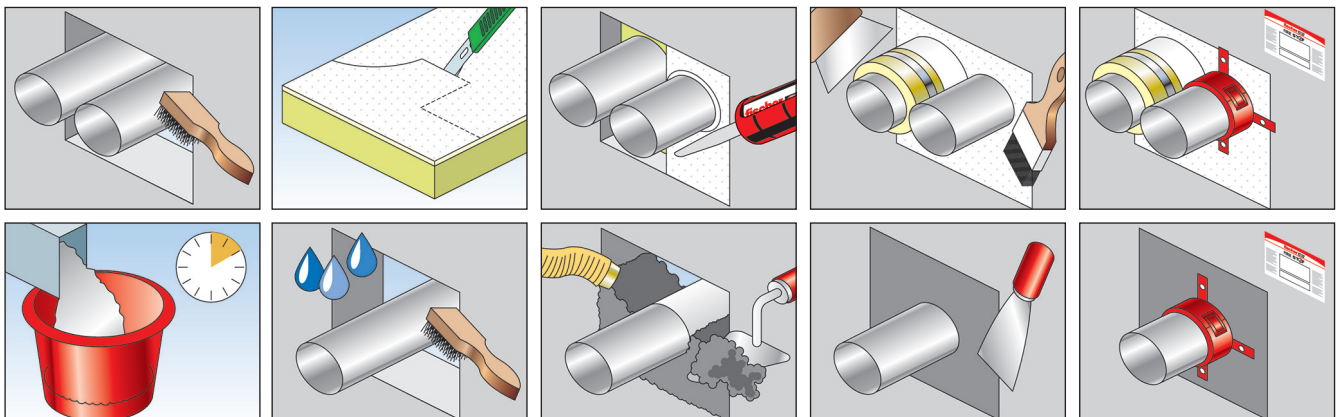

INSTALLATION

1. Clean all contact surfaces so they are free from loose debris and contaminants.
2. Ensure services are sufficiently supported as per approved system or local building codes.
3. Close the annular space as per requirement with FiAM, FCPS or FFSC and choose the correct size of FFC in accordance with the pipe diameter.
4. Open the toggle clip, place FFC around the pipe with its fixing lugs pointing towards the building element.
5. Lock the toggle clip and push it tightly against the surface of building element.
6. Attach the collar to the building element through the mounting lugs with a minimum anchoring depth of 32 mm and minimum 8 mm diameter fixing (please refer to fischer fire rated fixing section for correct anchor).
7. For vertical applications, repeat installation on both sides as per the instruction in the approved system.

SPECIFICATIONS

Item	Art.-No.	Dimensions	Sales unit
		B x L x H [mm / inch]	[pcs]
FFC 2/30-32	052456	30 - 32	1
FFC 2/38-40	052480	38 - 40	1
FFC 2/55	052481	55	1
FFC 2/63	052482	63	1
FFC 2/75	052483	75	1
FFC 2/82	052486	82	1
FFC 2/90	052487	90	1
FFC 2/110	052488	110	1
FFC 2/125	052489	125	1
FFC 2/160	052500	160	1
FFC 2/200	052501	200	1

TECHNICAL DATA

State	Solid
Colour	Red sleeve with black inner component
Odour	Odourless
Fire rating	Up to 4 hours
Available sizes	> 30 mm and max up to 200 mm
Significant expansion occurs at temperature	> 180 °C
Storage temperature	N/a
Shelf life	N/a

Fast and efficient solution for forming service penetrations through concrete floors

2 Products

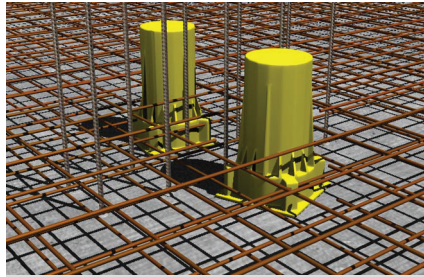
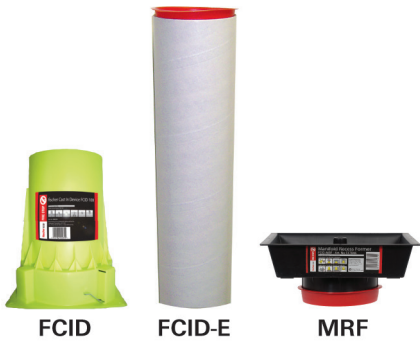

Installation of FCID within reinforced concrete floor

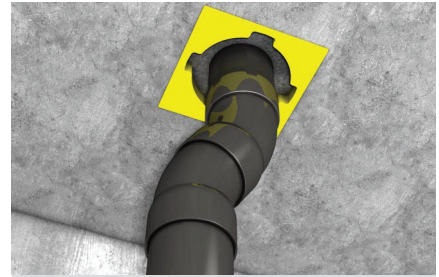

Installed pipe through FCID device

BUILDING MATERIALS

- Reinforced cast concrete slabs
- Some prefabricated slab systems (subject to design)

ASSESSMENT/APPROVAL

British Standard	Australian Standard
BS 476 - 20	AS 1530: Part 4

ADVANTAGES

- Quick installation
- Watertight seal
- Higher tolerance
- Easily extendable
- Wider base for further connections
- No further collars or wraps required
- Reduce working at heights
- Cost saving
- Reduced foot plate
- Eco-friendly extension tube
- Closer proximity positioning

APPLICATIONS

- Sealing and firestopping PVC and HDPE pipes up to 6" (160 mm)
- Forms holes up to 10" (200 mm) thick concrete floors
- FCID and MRF creates recesses in slabs for lower positioning of soil
- Manifold units in wet room applications

FUNCTIONING

- FCID is a pass through system, which is constructed from a highly resilient polypropylene material and contains a powerful intumescent graphite band.
- The FCID is rugged enough to withstand the force and load of a concrete pour, yet lightweight enough to permit easy placement and handling.

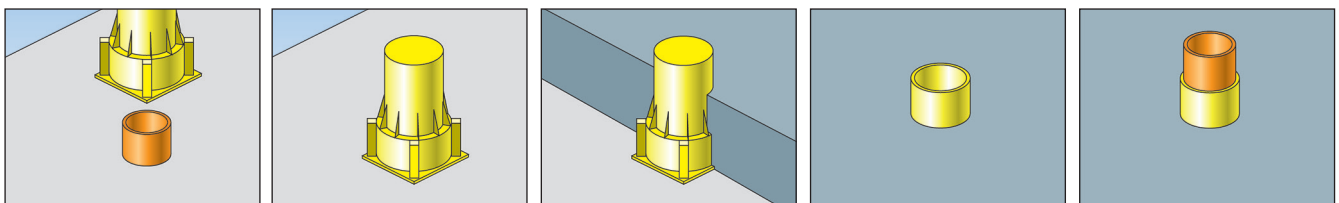

INSTALLATION

1. Position FCID as required and attach to formwork.
 - For concrete slab thickness greater than 250 mm:**
 - i) Remove end cap from FCID.
 - ii) Using FCID extension sleeve FCID - E Extension Tube, mark and cut using a fine tooth saw to required length.
 - iii) Slide extension sleeve over FCID unit until it contacts side ribs.
 - iv) Apply FCID - E/C Extension Cap to top of the extension sleeve.
 - v) Position FCID and extension assembly as required and attach to formwork.
 - For concrete slab thickness less than 250 mm:**
 - i) Cut FCID to required depth of concrete slabs.
 - ii) Place cover cap FCID - CP Cap Plug on top of FCID.
 - iii) Position FCID as required and attach to formwork.
2. Pour concrete to required depth.
3. On completion of concrete curing, remove all formwork and shuttering as necessary.
4. Remove cap from top of FCID and place pipe through FCID as required.

SPECIFICATIONS

Item	Art.-No.	Fits pipe-Ø	Hight x Shell diam.	Sales unit [pcs]
FCID 65 Cast in Device	509532	Nom 3"/75 mm Pipe	95 mm OD x 250 mm high - base = 154 mm x 154 mm	1
FCID 100 Cast in Device	506324	Nom 4"/110 mm Pipe	140 mm OD x 250 mm high - base = 198 mm x 198 mm	1
FCID 150 Cast in Device	509533	Nom 6"/160 mm Pipe	194 mm OD x 250 mm high - base = 253 mm x 253 mm	1
FCID 65-E/1000 Extension Tube	509791	FCID 65 CI	95 mm ID x 101 mm OD x 1000 mm long	1
FCID 100-E/1000 Extension Tube	509792	FCID 100 CI	140 mm ID x 147 mm OD x 1000 mm long	1
FCID 150-E/1000 Extension Tube	509793	FCID 150 CI	194 mm ID x 201 mm OD x 1000 mm long	1
FCID 65-C Extension Cap	511450	FCID 65-E/1,000	93.5 mm - 96.5 mm tapered OD x 19 mm high	1
FCID 100-C Extension Cap	509794	FCID 100-E/1,000	139 mm - 142.5 mm tapered OD x 25.4 mm high	1
FCID 150-C Extension Cap	511451	FCID 150-E/1,000	194.5 mm - 199 mm tapered OD x 25.4 mm high	1
FCID-MRF Manifold Recess Former	517846	FCID 100 CI	250 mm - 220 mm x 250 mm - 220 mm x 60 mm tapered recess	1
FCID 65-CP Cap Plug	510878	FCID 65 CI	88 mm - 91.5 mm tapered OD x 19.5 mm high 131.5 mm - 136 mm tapered OD x 25.4 mm high	1
FCID 100-CP Cap Plug	510879	FCID 100 CI	131.5 mm - 136 mm tapered OD x 25.4 mm high	1
FCID 150-CP Cap Plug	510880	FCID 150 CI	186 mm - 194 mm tapered OD x 25.4 mm high	1

Note: Details on 4 hours fire rated wraps are available on request.

TECHNICAL DATA

State	Solid
Colour	Fluorescent yellow
Odour	Odourless
Shell material	Polyethylene
Fire rating	4 hours - BS 476: Part 20 and AS 1530: Part 4
Suitable for pipe diameter	Max up to 150 mm
Standard height	250 mm
Extension or reduction in height possible	Yes
Standard flange width	Min. 154 mm and max 254 mm
Significant expansion occur at temperature	> 160 °C
Storage temperature	N/a
Shelf life	N/a

FireStop solution for temporary and permanent service penetrations in both vertical and horizontal applications

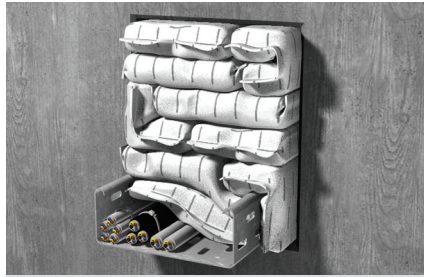

Wall application

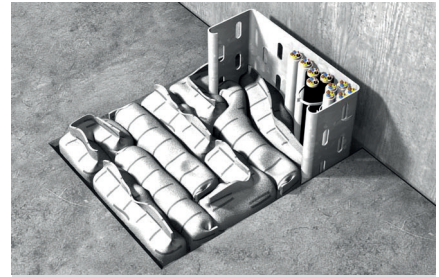

Floor application

Products

2

ASSESSMENT/APPROVAL



British Standard

BS 476 - 20

BS EN 1366-3

BS EN ISO 10140-3:1995



ADVANTAGES

- Approved as permanent fire barrier
- Reusable
- Dry installation
- Quick and easy installation
- No shelf life
- Moisture resistant
- Up to 2 hours fire protection

APPLICATIONS

- Metal pipes
- Cables/cable trays

FUNCTIONING

- FiP is an intumescent graphite and mineral fibre blend covered in a glass fibre PVC coated cloth bag.
- FiP is suitable for applications where temporary and permanent fire barriers are required.

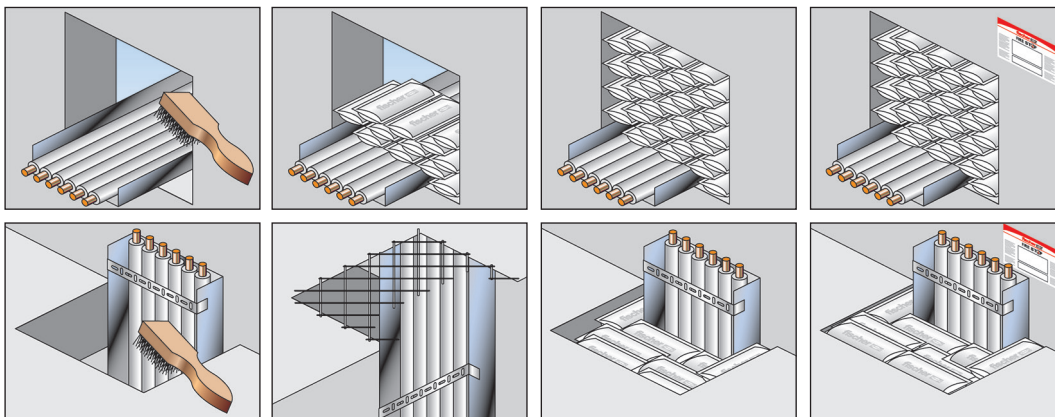

INSTALLATION

1. Clean all contact surfaces so they are free from loose debris and contaminants.
2. Ensure services are sufficiently supported as per approved system or local building code.
3. Shake the pillows to make the infill material uniform before installation.
4. Push the pillow into the hole so that the longest dimension spans across the wall. If installing in floor, mechanically fix galvanised steel mesh 50 x 50 x 5 mm to the underside of the opening with a 100 mm overlap of the floor slab.
5. Pack the pillows in a brick bond fashion, to ensure the joints between the pillows are staggered. Use small-sized pillows in between to pack the hole tight against the edges.
6. For electrical trunking, remove the lid and install a pillow inside so it aligns with the depth of the wall. Replace the lid on the electrical trunking.

SPECIFICATIONS

Item	Art.-No.	Dimensions [mm]	Sales unit [pcs]
FiP/S	516960	330 mm x 50 mm x 20 mm	50
FiP/Std	533890	330 mm x 100 mm x 20 mm	25
FiP/M	516959	330 mm x 200 mm x 25 mm	50
FiP/L	516958	330 mm x 200 mm x 45 mm	25

TECHNICAL DATA

State	Solid
Colour	Black
Odour	Odourless
Weight per pillow	FiP/S - 80 g, FiP/Std - 120 g, FiP/M - 230 g, FiP/L - 420 g
Volumetric expansion	3 times
Significant expansion occurs at temperature	> 140 °C
Remain flexible between	-20 °C to 130 °C
European Technical Approval	ETA 14-0380
CE marking	1121-CPR-JA5046

ESTIMATION QUANTITIES

Width [mm]	Size Seal type	Length [mm]											
		100		300		500		700		900		1,000	
		Large	Medium	Large	Medium	Large	Medium	Large	Medium	Large	Medium	Large	Medium
200	Wall	3	5	7	13	12	22	17	31	21	39	24	47
	Floor	2	3	4	7	6	12	9	17	11	22	12	27
400	Wall	5	9	14	26	24	44	33	61	42	78	47	95
	Floor	3	5	7	15	12	24	17	34	22	43	24	52
600	Wall	7	13	21	39	35	65	49	91	63	117	70	143
	Floor	4	7	11	22	18	36	25	51	33	65	36	79
800	Wall	9	18	28	52	47	87	66	122	84	157	94	192
	Floor	5	10	15	29	24	48	34	67	33	87	48	107
1,000	Wall	10	22	35	65	59	109	82	152	105	196	117	217
	Floor	6	12	18	36	30	60	42	84	54	108	60	120

Intumescent Putty Pad FiPP

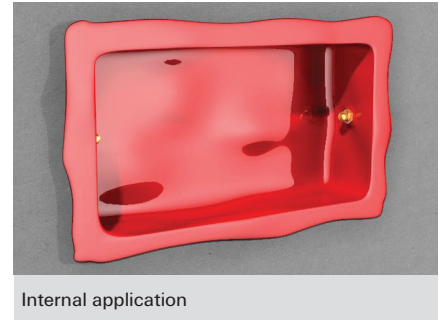
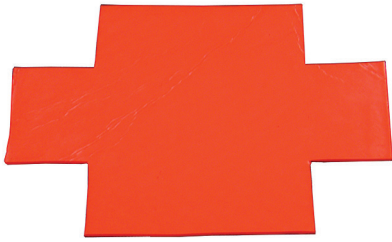

2
Products

BUILDING MATERIALS

- Most flexible wall partitions constructed from plasterboard/gypsum board, timber and steel studs

ASSESSMENT/APPROVAL

- British Standard**
- BS EN 1366-3**
- BS EN 1026**
- BS EN ISO 10140-3:1995**

ADVANTAGES

- Excellent acoustic properties
- Internal and external versions available
- Primerless adhesion to most substrates
- Robust detail part E handbook accepted
- No electrical conductivity
- Air permeability
- Quick and simple installation

APPLICATIONS

- Most flexible partition assemblies
- Fire and insulation resistance
- Acoustic sealing
- Air permeability
- Plastic and metal electrical outlets

FUNCTIONING

- Can maintain the fire resistance and insulation of flexible wall partitions, where they are penetrated by plastic or metal electrical outlets and cables.
- FiPP can also be used for upgrading the acoustic performance of flexible partitions.

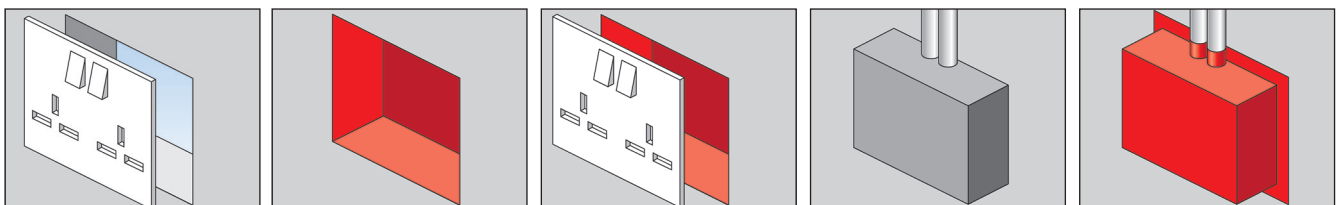

INSTALLATION

Internal
1. Remove the face-plates of the electrical outlet.
2. Clean all contact surfaces so they are free from loose debris and contaminants.
3. Mould the preformed putty pads into the back of the box and around the cables.
4. Replace the face-plate.
External
1. Clean all contact surfaces so they are free from loose debris and contaminants.
2. Mould the preformed putty pads onto the back of the box and around the cables.

SPECIFICATIONS

Item	Art.-No.	Dimensions [mm]	Colour	Fire rating	Sales unit [pcs]
FiPP/I-S	053578	170 x 170	red	2	25
FiPP/I-D	054757	230 x 170	red	2	50
FiPP/E-S	506261	155 x 155	red	2	25
FiPP/E-D	506262	210 x 180	red	2	–

TECHNICAL DATA

Base material	Drywall
Specific gravity	1.55 kg/m ³
Sound transmission class (Rw of partition and specimen)	66 dB
Slump	Nil
Application temperature range	+4 °C to 40 °C
Service temperature rate	-70 °C to 120 °C
Shelf life	18 months

FireStop coated panel system for multiple service penetrations

2
Products

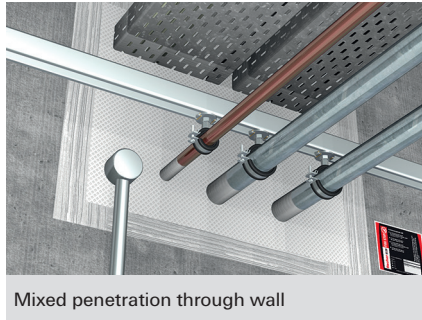

Mixed penetration through wall

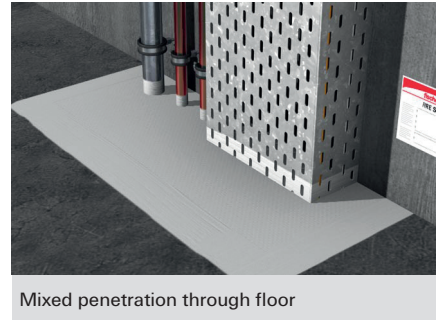

Mixed penetration through floor

ASSESSMENT/APPROVAL



British Standard
BS 476-20

BS 476: Part 22

BS EN 1366-3

BS EN ISO 10140-3:1995

ADVANTAGES

- Approved for light partition walls
- Can be installed dry
- No coatback required for services
- Excellent acoustic properties
- Asbestos and halogen free

APPLICATIONS

- Small and large openings
- Cables/cable trays
- Metallic or non-metallic pipes

FUNCTIONING

- FCPS is a rock fibre core coated with ablative sealant FPC for use in both vertical and horizontal applications.
- It maintains the sound reduction index of a structure.
- The FCPS will allow additional services to be added or removed and will accommodate thermal and mechanical movement of services.
- FPC can be used to adhere sections of FCPS board when jigsaw assembly is required and can also be used to enhance smoke and acoustic performance.

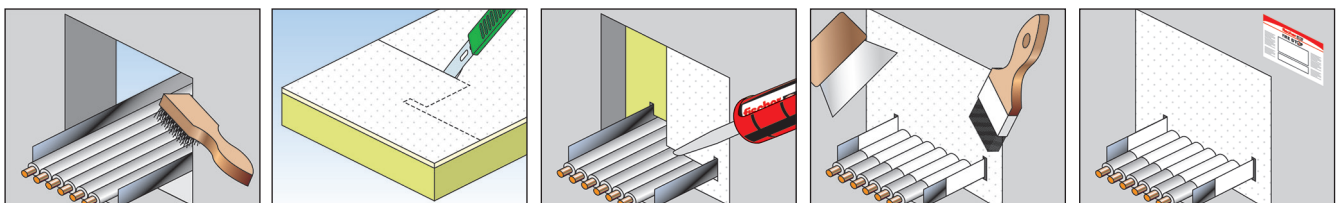

INSTALLATION

1. If opening size is greater than 1,200 x 1,200 mm then a steel angle for mechanical support should be installed as per detailed instruction or approved system.
2. Clean all contact surfaces so they are free from loose debris and contaminants.
3. Cut FCPS as per the required opening size, so that it can be fitted under friction into aperture with as few joints as possible.
4. Prior to installation, coat all exposed areas of FCPS with FPC.
5. Install FCPS section into aperture so it is compression fitted.
6. For multiple or mixed services passing through opening please use appropriate fire stopping device:
 - a. Use FiAM for metallic pipes, cables, cable trays and ducts.
 - b. Use FiPW for non-metallic pipes.

SPECIFICATIONS

Item	Art.-No.	Dimensions D x S x L x B [mm]	Contents	Contents	Suitable for use with	Sales unit
			[l]	[ml]		[pcs]
FCPS/50	053252	1200 mm x 600 mm x 50 mm	–	–	–	1
FPC/5lt	053253	–	5	–	–	1
FiAM 310	053011	–	–	310	–	25
KP M2	053117	–	–	–	FiAM 310, FFRS 310, UFS 310, FiGM 310	1

TECHNICAL DATA

Dimensions	1200 mm x 600 mm x 50 mm
Density of board	140 kg/m ³
Coating thickness	1 mm DFT
Fire resistance	Depending on application
Acoustic performance	23 dB mean reduction up to 56 dB reduction (with one 50 mm FCPS board), 29 dB mean reduction up to 65 dB reduction (with two 50 mm FCPS board)
Thermal conductivity (U value)	0.034 W/mK at 10 °C
Maximum size of seal	Wall 5.76 m ² , floor 2.88 m ²
Maximum size unsupported	1.2 m x 1.2 m (no services)
Mechanical support	30 mm x 30 mm x 1.6 mm steel angle
Density of panel coating FPC	1.25 - 1.3 g/cm ³
Panel coating FPC coverage	3.5 litres/m ²
Shelf life of board	N/a
Shelf life of panel coating FPC	12 months
European Technical Approval	ETA 14-0388 and ETA 14-0382
CE marking	1121-CPR-JA5050

Note: Please refer to the appropriate approvals for details.

APPLICATION DATA

Services	Rigid partition walls	Flexible partition walls	Concrete floors
	[Fire rating - hours]	[Fire rating - hours]	[Fire rating - hours]
Cable ladder/tray/basket	up to 2	up to 2	up to 2
Cables up to 26 mm diameter	up to 2	up to 2	up to 2
Cables up to 80 mm diameter	up to 2	up to 2	up to 2
Steel/Copper pipes up to 159 mm diameter	up to 2	up to 2	n/a
PVC pipes* up to 110 mm diameter	up to 1	up to 1	n/a
Blank seals	up to 2	up to 2	up to 2

PVC Pipes must be protected in conjunction with FiPW, which must be securely sealed in place within the FCPS.

Structural fire resistant seal for floors and walls

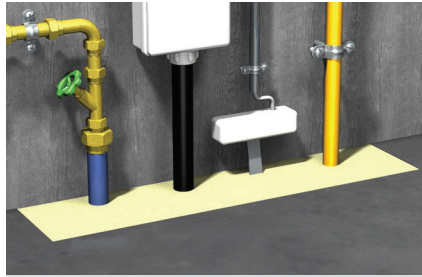

Mixed service penetrations

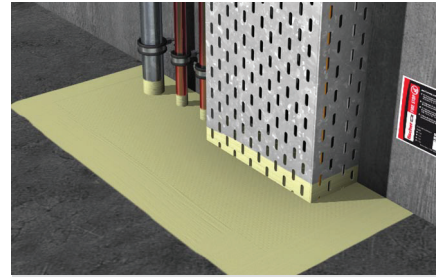

Mixed service penetrations

2
Products

ASSESSMENT/APPROVAL



British Standard

BS 476-20

BS EN ISO 10140-3:1995

BS EN 1366-3



American Standard

**ASTM E 814
(UL 1479)**

ADVANTAGES

- Water based
- Low VOC
- Load bearing
- Excellent acoustic properties
- Both vertical and horizontal applications
- Halogen and asbestos free

APPLICATIONS

- Metallic services with steel and cast iron pipes
- Non-metallic services with FiP intumescent pipe wrap or FFC
- Voids or cavities in floors or walls
- Cable bunches

FUNCTIONING

- FFSC is a specially formulated gypsum based compound, which when mixed with water can be trowelled or poured.
- FFSC can provide up to 4 hours integrity and insulation.
- Set within 45 min depending on ambient temperature.
- Capable of accommodating foot traffic within 72 hours.

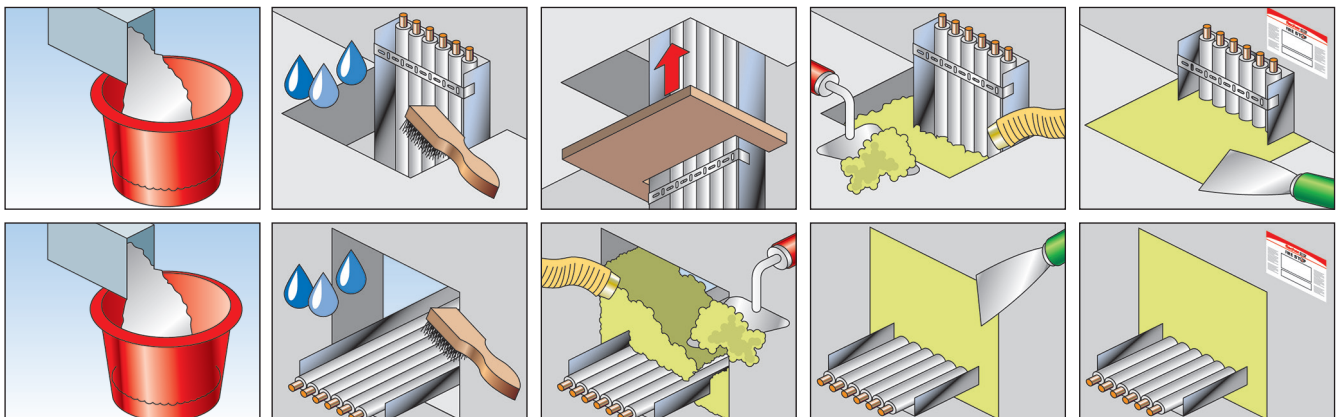

INSTALLATION

1. Service penetrations should be rigidly supported as per local building codes or approved standards.
2. Clean all contact surfaces so they are free from loose debris and contaminants such as oil, dirt, grease, wax, old sealant, etc.
3. Pouring: Mix compound with water in 2.5:1 parts by volume. Do not mix weaker than 2:1.
4. Shutter into the opening to ensure a tight fit so that once the required depth of compound is installed, it finishes flush with the floor.
5. Mix and pour compound until the required thickness is achieved.
6. If the opening is greater than 1,200x1,200 mm, appropriate reinforcement may be required.

SPECIFICATIONS

Item	Art.-No.	Weight	Sales unit
		[kg]	[pcs]
FFSC/20 kg	533247	20	1

TECHNICAL DATA

Chemical base	Gypsum
Colour	Off white
Weight	20 kg
Bulk density	950 kg/m ³
Wet density	1,850 kg/m ³
Setting time (min)	20
Application temperature range	+5 °C to +40 °C
Temperature resistance	-5 °C to +100 °C
Compressive strength	17 N/mm ²
Sound insulation (Rw partition and specimen)	59 dB
Reaction to fire (EN13501-1)	Class F
Shelf life	12 months
European Technical Approval	ETA 14-0387
Tensile strength	30/mm ²
Thermal conductivity – EN1745	0.57 W/mK at 50 % /0.65 W/mK at 90 %
Average yield	4 bags per M ² at 100 mm thickness

APPLICATION DATA

	By volume
	Powder to water ratio
Pourable grade	2.5:1
Trowelable grade	3:01

* These are approximate calculations based on 20 kg bags. The coverage does not take into account the percentage of the hole filled with services.

** As a further safety margin, we would recommend that all floor seals with clear areas greater than 1,100 mm x 1,100 mm must be reinforced.

Load bearing note: the open area free of services: Thickness of seal ratios for non-reinforced seals given above allow an ample safety margin for normal foot traffic, e.g., loads of two men plus equipment with a combined weight up to 200 kg.

Effective ventilated fire barrier designed to close the void between the inner and outer construction elements



FFB-VS VentiStop installed with Multi-Purpose Bracket



FFB-VS VentiStop installed with DHM Anchor

2
Products

BUILDING MATERIALS

- Concrete slabs, columns and walls
- Curtain wall assemblies
- Stone cladding, etc.

ASSESSMENT/APPROVAL

BS EN 1363-1-TG19

ADVANTAGES

- Tested up to 120 minutes integrity and 90 minutes insulation utilising the heating and pressure conditions of EN 1363-1: 2012 and ASFP TDG19: 2014 - Open State Cavity Barriers.
- Suitable to close 25 & 50 mm ventilation gap
- Voids up to 350 mm wide
- Free of halogens, asbestos, fibres and silica and is non-toxic
- Long life expectancy
- Contributes to green building

APPLICATIONS

- Horizontal cavities between the inner and outer construction elements

FUNCTIONING

- FFB-VS a foil-faced stone wool pre-cut unit, which has a powerful intumescent graphite strip bonded to the exposed face. The intumescent graphite strip is pre-wrapped with a durable polythene adhesive sheet to prevent water ingress.
- FFB-VS has been designed to provide a 25 & 50 mm ventilation gap, that allows air flow and moisture to pass down the back of the cladding. Under fire conditions, the powerful intumescent along the front edge expands horizontally to close the gap and prevent the passage of fire.

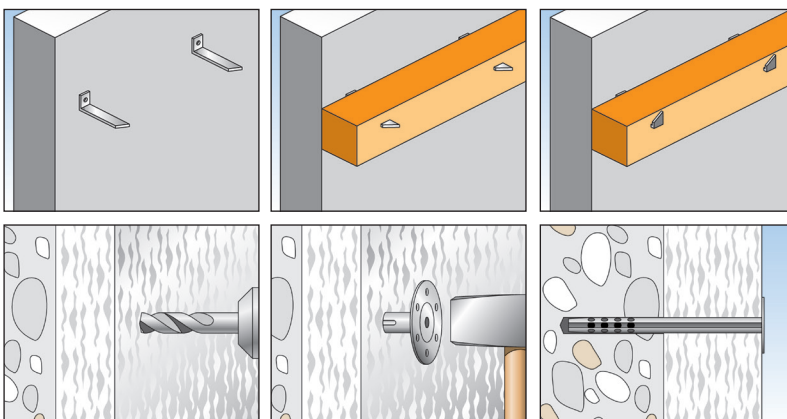

SPECIFICATIONS FFB-VS

Item	Art.-No.	To suit cavity void width [mm]	Colour	Sales unit [pcs]
FFB-VS/25-50	521520	25 - 50	Red/silver/black	48
FFB-VS/51-100	521521	51 - 100	Red/silver/black	24
FFB-VS/101-150	521522	101 - 150	Red/silver/black	48
FFB-VS/151-200	521523	151 - 200	Red/silver/black	14
FFB-VS/201-250	521524	201 - 250	Red/silver/black	11
FFB-VS/251-300	521525	251 - 300	Red/silver/black	11
FFB-VS/301-350	521526	301 - 350	Red/silver/black	TBA
FFB-VS/351-400	521527	315 - 400	Red/silver/black	9
FFB-VS/401-450	521528	401 - 450	Red/silver/black	6

IMPORTANT: Please provide TOTAL cavity width for your application, excluding any insulation there might be.

SPECIFICATIONS FFB-VS50

Item	Art.-No.	To suit cavity void width [mm]	Colour	Sales unit [pcs]
FFB-VS50/51-100	545628	51 - 100	Red/silver/black	48
FFB-VS50/101-150	545629	101 - 150	Red/silver/black	24
FFB-VS50/151-200	545630	151 - 200	Red/silver/black	48
FFB-VS50/201-250	545631	201 - 250	Red/silver/black	14
FFB-VS50/251-300	545632	251 - 300	Red/silver/black	11
FFB-VS50/301-350	545633	301 - 350	Red/silver/black	11
FFB-VS50/351-400	545634	351 - 400	Red/silver/black	TBA
FFB-VS50/401-450	545635	401 - 450	Red/silver/black	9

IMPORTANT: Please provide TOTAL cavity width for your application, excluding any insulation there might be.

TECHNICAL DATA

Description	Foil faced stone with a black intumescent leading edge
Fire resistance - FFB-VS	Up to 120 minutes
Closure time - FFB-VS	needs to be < 5 min
Activation	Approx. 180 °C (intumescent material)
Expansion pressure	Approx. 07 N/mm ²
Density	Stone wool - 80 kg/m ³ intumescent 1.3 g/cm ³
Weather resistance	Yes
Sag	0 %
Open void size - FFB-VS	25 mm to 50 mm
Dimensions	80 mm Thick 1000 mm Long
Width	FFB-VS (30 mm to 450 mm)
Fixing points (Brackets or DHM Anchor)	FFB-VS (300 mm Centres)

MULTI PURPOSE BRACKET

Item	Art.-No.	To suit cavity void width [mm]	Colour	Fire rating	Sales unit [pcs]
Multi Purpose Bracket	551868	390 x 25 x 1 (A2)	silver	N/A	1
Multi Purpose Bracket	551954	500 x 25 x 1 (A2)	silver	N/A	1

Designed to protect the building void between the inner and outer construction elements

Products 2

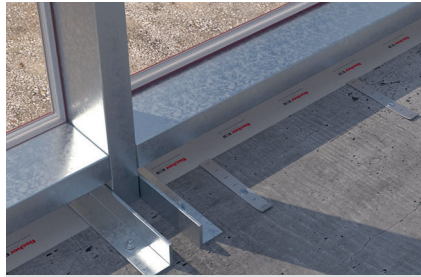
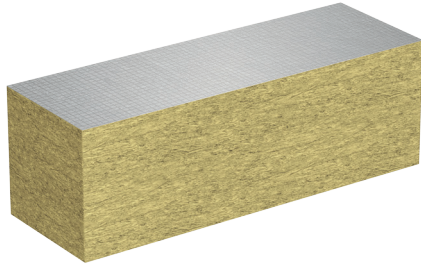

FCFcl Cavity Clad - Horizontal application



FCFcl Cavity Clad - Vertical application

BUILDING MATERIALS

- Concrete slabs, columns and walls
- Curtain wall assemblies
- Stone cladding, etc.

ASSESSMENT/APPROVAL



British Standard

BS 476 - 20

BS EN 1026

BS EN 1366-4: 2006

BS EN ISO 10140-3: 1995



Approved CF 5659

ADVANTAGES

- Tested to EN 1366-4 & BS 476
- Classification to EN 13501-2, EN 13501-1
- Air Permeability to EN 1026 to 600Pa
- Acoustic Isolation to EN 10140 to 31dB
- GWP of 0% Global Warming Potential
- ODP of 0% Ozone Depletion Potential
- Superior Level of Sustainability
- Encased Fibre Migration for Air Ple-num Use
- Long life expectancy
- Contributes to Green Building
- Floor & Wall voids up to 500 mm wide

APPLICATIONS

- Horizontal and vertical cavities between the inner and outer construction elements
- Ceiling Cavity Barriers
- Under Floor Cavity Barriers
- Slab Edge Barriers

FUNCTIONING

- FCFcl Cavity Clad comprises of a one piece closed dimension stone wool core.
- The product is encased with an aluminum foil face which provides class 'O' rating and exhibits excellent resistance to smoke.
- The FCFcl Cavity Clad provides a resilient lateral compression which is required to ensure a tight fit.

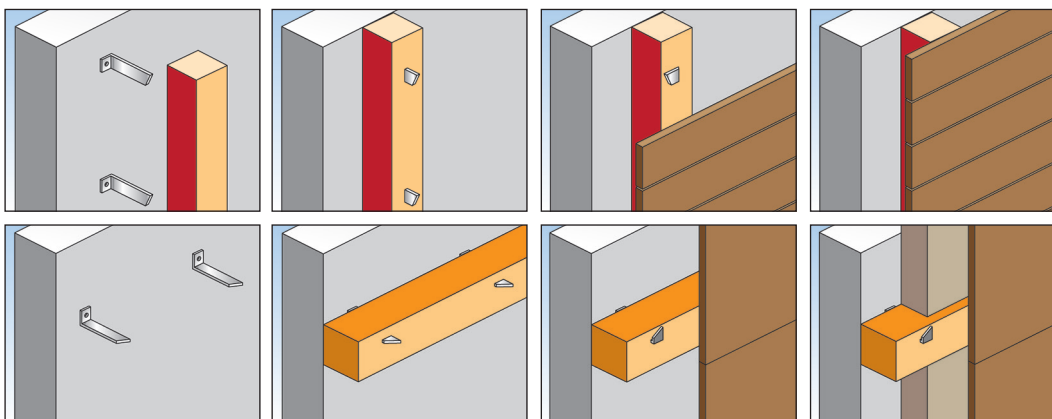

SPECIFICATIONS FCFCL

Item	Art.-No.	To suit cavity void width [mm]	Colour	Fire rating [hours]	Sales unit [pcs]
FCFcl 75	546210	1200 x 600 x 75	silver	up to 2*	1
FCFcl 100	053046	1200 x 600 x 100	silver	up to 2*	1
FCFcl 1200	546209	1200 x 1200 x 100	silver	up to 2*	1

IMPORTANT: Please provide TOTAL cavity width for your application, excluding any insulation there might be.

FCFcl Cavity Clad shall be cut 10 mm (3/8 in.) over size.

* Depending on design & configuration of the FCFcl Cavity Clad.

MULTI PURPOSE BRACKET

Item	Art.-No.	To suit cavity void width [mm]	Fire rating [hours]	Sales unit [pcs]
Multi Purpose Bracket	551868	390 x 25 x 1 (A2)	N/A	1
Multi Purpose Bracket	551954	500 x 25 x 1 (A2)	N/A	1

TECHNICAL DATA

Description	Foil faced structural stone wool composite
Fire resistance - FCFcl	BS467 20 / EN1366-4 up to 120min
Classification	EN 13501-2:2007 + A1:2009, ETAG 026
Thermal	0.35 to 0.36W/mk
Density	80 kg/m ³
Build	Stone wool - 80 kg/m ³ intumescent 1.3 g/cm ³
Acoustic (EN10140)	31db
Air permeability (EN1026)	600 pa - 100 pa 2.6/4.2 m ³ /h/m ²
Thickness	75 mm & 100 mm
Dimensions	1200 x 600 & 1200 x 1200
Compression	Min 10 mm
Brackets	Required over cavity of 150 mm (2 per meter)

A single component filler foam with effective fire resistance

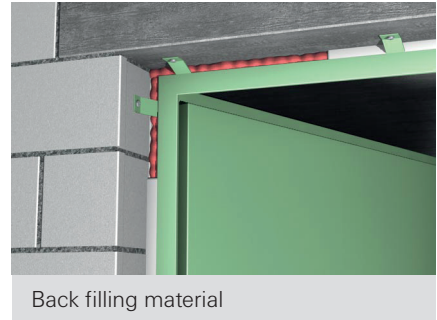
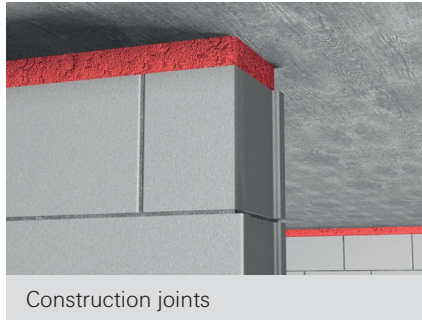

BUILDING MATERIALS

- Concrete
- Masonry
- Steel as backing material
- Timber as backing material

ASSESSMENT/APPROVAL

EN 1366-4

EN ISO 10140-3:1995

DIN

ADVANTAGES

- High foam yield
- No post shrinkage or expansion
- CFC free propellant
- Effective seal against smoke
- Rendered, cut, painted or sanded
- High bond strength
- Good adhesion to most building materials
- Excellent acoustic and thermal properties

APPLICATIONS

- Construction joints in walls and floors
- Insulating and sealing doors and windows: non-fire rated application
- Backfilling material only for service penetrations
- Filling general voids and cavities: nonfire rated application

FUNCTIONING

- FireStop Foam is a single component, self expanding polyurethane foam, which has been designed to be self curing via the absorption of moisture from the atmosphere.
- The foam has excellent adhesion properties and can adhere to most building materials. When the foam sets it cures to a semi-rigid structure, which accommodates low movement and vibration.

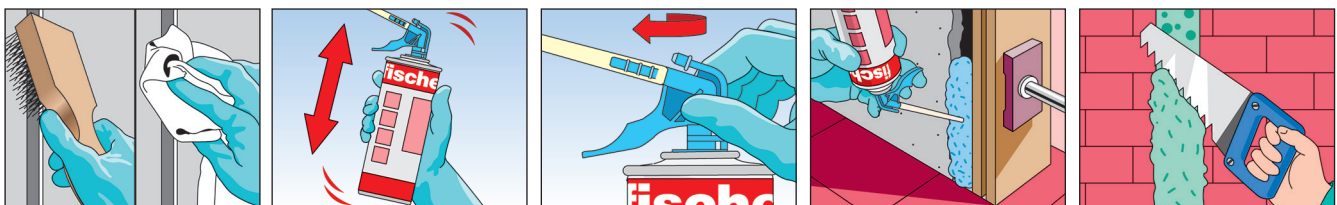

INSTALLATION

1. Clean all contact surfaces so they are free from loose debris and contaminants such as oil, dirt, grease, wax, old sealant etc.
2. Dampen the substrate surfaces with clean water before application to improve adhesion and curing rate.
3. Protect adjacent surfaces with paper or a plastic film.
4. Shake the canister vigorously at least 20 times before use, and again periodically during application.
5. Remove the cap and screw the nozzle firmly into the connector on the top of the valve.
6. Gently pull the trigger to dispense foam, whilst holding the canister inverted.
7. Fill approximately half of the required depth of the cavity to allow for expansion of the foam. Should gaps be more than 30 mm then, apply the foam in beads and pre-moisten between layers.
8. On horizontal surfaces always work away from the bead and work upwards on all vertical surfaces.
9. Please note that cured foam is adversely affected by UV light and should be protected with a suitable paint or sealant.

SPECIFICATIONS

Item	Art.-No.	Contents [ml]	Sales unit [pcs]
FireStop Foam Hand	042757	750	12
FireStop Foam Gun	043712	750	12

TECHNICAL DATA

Base	Polyurethane
Consistency	Stable foam
Curing system	Moisture-cure
Yield	1,000 ml yields 35 - 40 l cured foam when extruded in beads
Specific gravity	Ca. 27 kg/m ³ extruded, fully cured
Skinning formation (20 °C/65 % R.H.)	10 min
Drying time (20 °C/65 % R.H.)	Non tacky after approx. 8 min
Curing rate (20 °C/65 % R.H.)	hr for 30 mm bead
Shrinkage	None
Post expansion	None
Cellular structure	70 % closed cells, fine cellular structure
Temperature resistance	-40 °C to +90 °C when cured
Colour	Light red
Packaging	750 ml can
Storage temperature	+5 °C to +25 °C
Shelf life	Up to 12 months when stored in unopened cartridges under cool, dry conditions
Construction material as per DIN 4102	B1
STC rating	58 dB

Thermal defense wrap for high insulation and temperature stability

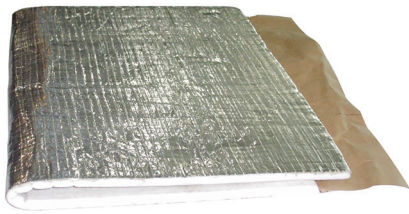

Cable tray application in wall



Cable tray application in floor

2 Products

ASSESSMENT/APPROVAL

British Standard

BS 476 - 20

BS EN 1366-3

BS EN ISO 10140-3:1995

ADVANTAGES

- Remains flexible -10 to +160
- Low VOC
- High insulation and temperature stability
- Pre-formed 300 mm roll
- Fast and efficient installation
- Remains flexible without aging

APPLICATIONS

- Metallic services with steel and cast iron pipes
- General construction joints: wall to floor to head of wall
- Drywall partitions, connections
- FCPS joints

FUNCTIONING

- TDW is ceramic-based technology of bio-soluble vitreous fibres and flexible organic binders, and has been designed to maintain the compartmentalisation of a fire-rated assembly.
- The unique design of the TDW allows for movement of services, maintain the necessary insulation of the services and prevents temperature rise of the services at the cold face. At normal temperature the TDW remains flexible and permits thermal and mechanical movement.
- It provides up to 2 hours integrity and insulation.

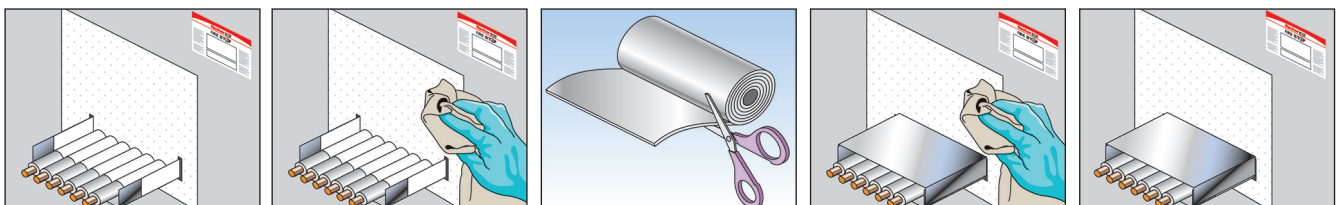

INSTALLATION

1. Clean all contact surfaces so they are free from loose debris and contaminants such as oil, dirt, grease, wax, old sealant, etc.
2. Measure and mark the TDW to the required service configuration.
3. Cut TDW as per requirements with a standard pair of scissors or snips.
4. Wrap TDW around service configuraion and apply alufoil tape to secure in place.

SPECIFICATIONS

Item	Art.-No.	Dimensions [mm]	Sales unit [pcs]
TDW 1	531398	300 x 15,000	1

TECHNICAL DATA

Odor and appearance	White, fibrous material with aluminium foil face
Chemical family	Calcium magnesium silicate fibres
Boiling point	N/a
Water solubility (%)	Less than 1 mg/l > 1200 °C
Relative density	180Kg/m3 - 250Kg/m3
Alufoil thickness	0.25 mm normal
Dimension (thickness mm)	6
Size (width x length mm)	300 x 15,000 long roll or 1,200 x 500 sheet
Shelf life	36 months (under recommended conditions)
Storage temperature	-5 °C to +25 °C
Colour	White, silver

Ablative firestop coating design to prevent the propagation of fire along internal and external electrical cable

Products

2



BUILDING MATERIALS

- Drywall
- Concrete
- Masonry

ASSESSMENT/APPROVAL



IEC 60331-21: 1999

EN 60332-3-22: 2010

EN 60332-1-2: 2004

ADVANTAGES

- Water based, odorless and solvent free
- Suitable for internal and external applications
- Quick curing
- Spray or brush applied
- Halogen, fibres and asbestos free
- High yield

APPLICATIONS

- Power plants (IEC 332 Pt3)
- Telecommunication
- Industrial plants
- Petrochemical plants
- Factories and production facilities

FUNCTIONING

- Can be sprayed, painted, or brush applied.
 - Multiple layers and overhead application possible due to its thixotropic consistency.
 - Base surface should be clean, dry and suitably prepared.
 - Thickness of application: see approval or test.
 - When exposed to fire, it reacts to form a highly isolative char that slows down heat transfer, and provides a protective fire barrier.
- When spray applied:
 Min. 170 bar
 Nozzle spray angle 40°
 Flow rate 0,78 mm
 Liters/minute 3,5

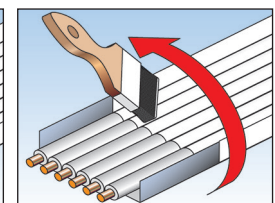
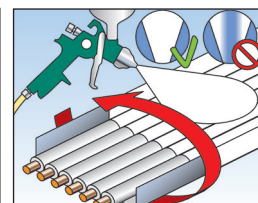
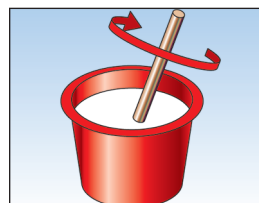
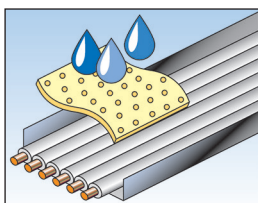

SPECIFICATIONS

Item	Art.-No.	Content [kg]	Sales unit [pcs]
FCC	539609	12.5	1

TECHNICAL DATA

Chemical base	Water-based
Density	1,55 g/cm ³
Application temperature	+ 5 °C to + 40 °C
Storage temperature	+5 °C to +30 °C to be protected from frost and direct sunlight
Odour	slight
Water resistant	yes
Shelf life	1 year
pH Value	approx. 8
Coating thickness	0.5 - 0.8 mm (IEC 60332-3)
(Dry film)	1.6 mm (Factory Mutual)
Colour	White
Curing time at room temperature	1 - 3 days*

* Depending on humidity, air and ambient temperature.

FOAM GUNS

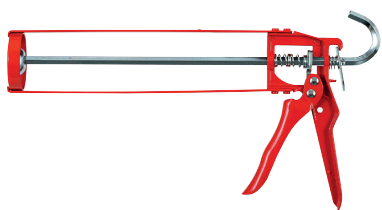

Skeleton dispenser **KP M1**



Dispenser **KP M2**



Dispenser **KP M3**

Item	Art.-No.	Adapted for	Sales unit [pcs]
KP M1	053115	FIAM, FFRS, UFS 310	1
KP M2	053117	FIAM, FFRS, UFS 310	1

FOAM GUNS



Applicator gun **KP M600**

Item	Art.-No.	Adapted for	Sales unit [pcs]
KP M600	540941	FIAM 600 ml	1

FOAM GUNS



Plastic dispenser **PUP K2**

Item	Art.-No.	Sales unit [pcs]
PUP K2	062400	1

FOAM GUN CLEANER



PUR 500 foam cleaner



PUR 150 foam cleaner

Item	Art.-No.	Contents [ml]	Adapted for	Sales unit [pcs]
PUR 500 (DE/EN)	053085	500	PUP K2 gun	12
PUR 150 (DE)	053083	150	PUP K2 gun	12

A guide to supporting sprinkler systems

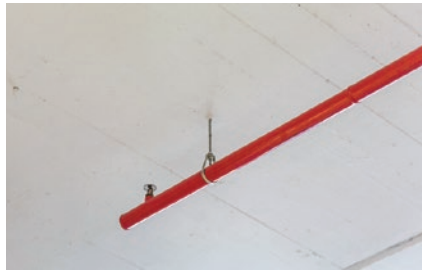

APPLICATIONS

- Industrial companies
- High-bay warehouses
- Office buildings
- Logistics areas
- Public buildings and institutions
- Sales entities
- High-rises
- Underground garages
- Museums
- Congress and conference centres

APPROVALS

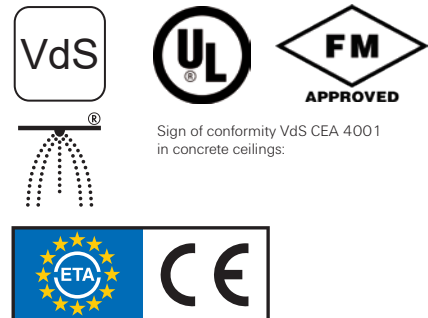

FUNCTIONING



Sprinkler systems fall into the category of active fire protection (AFP) and could be considered as detection and suppression systems, which usually covers the complete floor plan. This means that sprinklers are usually installed in all rooms of a building and are designed in accordance with the actual fire hazard, the temperature - dependent opening of the sprinkler normally activates an acoustic sound and sends a signal to the fire control system. Over the past decade, sprinkler systems extinguishing rates have been high and, as a result, are standard in some types of buildings.

In general, sprinkler systems are designed in accordance with the following standards: VdS CEA 4001 Section 15.2.4 Anchorage in Concrete Ceilings, FM 1951 Section 3.2 Technical and Constructional Properties, UL 203 Section 11.3 Pipe Hangers for Fire Protection Systems, NFPA 13 Section 9.1.3 Fixings in Concrete and/or to EN 12845, which is an identical standard to CEA 4001.

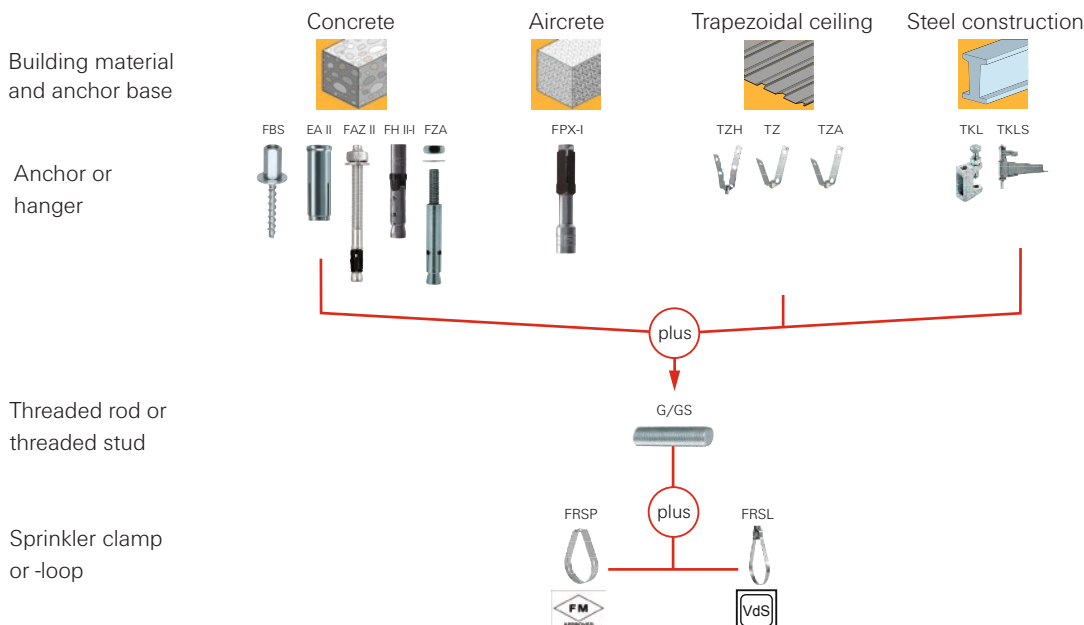



APPLICATION DATA



SPECIFICATIONS

Item	Type	Art.-no.	[Zoll] / [mm]
	FRSL 34	513302	1"
	FRSL 43	513303	1 1/4"
	FRSL 49	513304	1 1/2"
	FRSL 60	513307	2"
	FRSL 76	513308	2 1/2"
	FRSL 90	513309	3"
	FRSL 115	513310	4"
	FRSL 140	513311	5"
	FRSL 170	513312	6"
	FRSP 1/2"	524035	1/2"
	FRSP 3/4"	524036	3/4"
	FRSP 1"	524037	1"
	FRSP 1 1/4"	524038	1 1/4"
	FRSP 1 1/2"	524039	1 1/2"
	FRSP 2"	524040	2"
	FRSP 2 1/2"	524041	2 1/2"
	FRSP 3"	524042	3"
	FRSP 4"	524043	4"
	FRSP 5"	524044	5"
	FRSP 6"	524045	6"
	FRSP 8"	524046	8"
		ETR 8 - 13	024415
ETR 12 - 17		024416	M 6
ETR 15 - 21		024417	M 6
ETR 20 - 27		024418	M 8
ETR 26 - 34		024419	M 8
ETR 33 - 42		024420	M 8
ETR 40 - 49		024421	M 8
ETR 50 - 60		024422	M 8
ETR 60 - 70		024423	M 10
ETR 66 - 76		024424	M 10
ETR 70 - 82		024425	M 10
ETR 80 - 90		024426	M 10
ETR 90 - 102		024427	M 12
ETR 100 - 108		024428	M 12
ETR 102 - 114		024429	M 12
ETR 121 - 127		024430	M 12
ETR 126 - 133		024431	M 12
ETR 131 - 140		024432	M 14
ETR 143 - 153		024433 ¹⁾	M 14
ETR 150 - 159		024434	M 14
ETR 168		024435	M 14
ETR 193.7		024436	M 14
ETR 219		024437	M 14

1) This article is delivery on request only.

Item	Type	Art.-no.	[Zoll] / [mm]
	G 8	079740	1000
	G 10	079744	1000
	G 12	020957	1000
	G 16	020958	1000
	G 8/2	079741	2000
	G 10/2	079745	2000
	G 12/2	579746	2000
	G 10/3	557092	3000
	G 12/3	064056	3000
		GS 8/25	079750
GS 8/40		079751	40
GS 8/50		079752	50
GS 8/60		079753	60
GS 8/70		079754	70
GS 8/80		079755	80
GS 8/90		079756	90
GS 8/100		079757	100
GS 8/150		079758	150
GS 8/200		079759	200
GS 10/25		079765	25
GS 10/40		079766	40
GS 10/60		079767	60
GS 10/80		079768	80
GS 10/100		079769	100
GS 10/120		079770	120
GS 10/150	079771	150	
GS 10/200	079772	200	
	TKL L M 8	064055	M 8
	TKL M 8	079687	M 8
	TKL L Ø 9	077605	Ø 9
	TKL M 10	079688	M 10
	TKL Ø 11	079689	Ø 11
	TKL M 12	020949	M 12
	TKL Ø 13	043275	Ø 13
	SS-TKL M10/M12	048154	M10/M12
	TKLS Ø 9	531134	Ø 9
	TKLS Ø 11	531136	Ø 11
	TKLS Ø 13	531137	Ø 13
	TKLS Ø 17	531138	Ø 17
	TZ M 8	064094	M 8
	TZ M 10	064095	M 10
	TZH M 8	079825	M 8
	TZH M 10	079826	M 10
	TZA M 10	524047	M 10

Please refer to our comprehensive main catalogue or our online web catalogue updated daily at www.fischer.de for information on further additions to our product and entire range.

ANCHOR APPROVAL OVERVIEW



Item	ETA concrete single	ETA concrete multiple	ETA air crete	VdS-compliant	VdS-approved	FM-approved
FAZ II	Option 1			✓		✓
FBS	Option 1	✓ (FBS 6)		✓		
FH II	Option 1			✓		✓
FZA	Option 1			✓		✓
FZEA II	Option 1			✓		✓
EA II	Option 7	✓		✓		✓
FNA II		✓		✓		
FPX-I			✓		✓	

ETA concrete, single, option 1 = suited for cracked and non-cracked concrete

ETA concrete, single, option 7 = suited for non-cracked concrete

ETA concrete, multiple = suited for cracked and non-cracked concrete

Fire protection inspections for SaMontec products

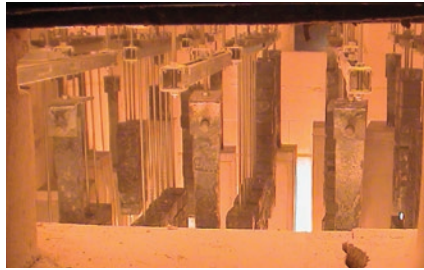

TEST CURVE

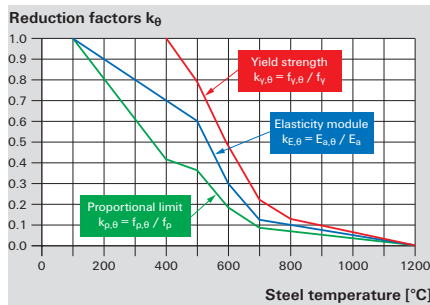

Dependency of the yield strength, proportional limit and elasticity module on the temperature (basis: EN 1993-1-2:2012-12 Eurocode 3).

ADVANTAGES

- Single, multi or uniform load tested
- Full range of pipe clamps
- Rails and supports

APPROVALS



FUNCTIONING

Fire protection in buildings covers the safety of occupants, fire fighters and contents, and is regulated by the local building codes or standards. This is particularly evident in the installation of fire protection systems such as a detection or suppression, as approved or recognized components must be used. The key message is to ensure the safety of the escape route by ensuring the functioning of the supports and sub frames will remain integral for a set period of time.

The necessity for these considerations arises from the properties of the steel, which is subjected to a loss of yield when it reaches a temperature of $> 600\text{ }^{\circ}\text{C}$ and therefore components can undergo a series of resistance testing. The same information is documented in the inspection reports for a fire resistance with ratings of R30, R90 and R120, based on the standard pipe systems directive of 2005 (MLAR 2005) and according to EN-1363-1 and DIN4102-2

SPECIFICATION



FRS



FUS 41



FUS 62

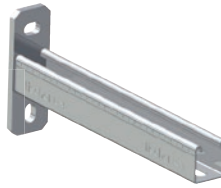

FCA



SB



SBS



PDH-K

Item	Document no.	MLAR	R30 - R120	F30 - F120
FRS	MFPA Leipzig-GS3.2/14-175-2	●	●	
FUS	MFPA Leipzig-GS3.2/14-175-4	●	●	
FCA	MFPA Leipzig-GS3.2/14-175-4	●	●	
SB	MPA-NRW- 210005109 - 7			●
SBS	MPA-NRW- 210005109 - 4	●		●
PDH-K	MPA-NRW- 210005109 - 6	●		●

FUS-Channel / FCA-Cantilever arm - Load table based on the advisory opinion no. GS 3.2/14-175-4

FUS/FCA 41/2.5 (picture 1-3)		MLAR - loads			Max. Loads			
Threaded rods ≥ 4.8		strain	F-resistance	Max. strain	Fire resistance time [minute]			
Load case	l_s	$\min a^{1)}$	30	$\min a^{2)}$	30	60	90	120
	[mm]	[mm]	[kN]	[mm]	[kN]	[kN]	[kN]	[kN]
Point load	≤ 400	≤ 50	0.90	278	2.40	1.33	0.92	0.72
	≤ 700	≤ 50	-	320	1.61	1.04	0.80	0.67
multiple load ³⁾	≤ 400	≤ 50	0.90	278	2.40	1.33	0.92	0.72
	≤ 700	≤ 50	-	320	1.61	1.04	0.80	0.67
Uniformly distributed load	≤ 400	≤ 50	1.50	258	3.00	2.10	1.41	1.06
	≤ 700	≤ 50	0.60	299	2.44	1.57	1.21	1.00
	≤ 1.250	≤ 50	-	468	3.29	1.81	1.27	0.98

FUS / FCA 62/2.5 (Pict. 1-3)		MLAR			Max. Loads			
Threaded rods ≥ 4.8		strain	F-resistance	Max. strain	Fire resistance time [minute]			
Load case	l_s	$\min a^{1)}$	30	$\min a^{2)}$	30	60	90	120
	[mm]	[mm]	[kN]	[mm]	[kN]	[kN]	[kN]	[kN]
Point load	≤ 400	≤ 50	1.76	25	1.76	1.06	0.78	0.62
	$\leq 1,000$	≤ 50	-	460	2.27	1.31	0.93	0.72
multiple load ³⁾	≤ 400	≤ 50	1.76	25	1.76	1.06	0.78	0.62
	$\leq 960^{4)}$	≤ 50	4.30	550	4.30	2.14	1.39	1.01
	$\leq 1,000$	≤ 50	0.55	661	2.52	1.60	1.21	0.99
Uniformly distributed load	≤ 400	≤ 50	1.76	25	1.76	1.06	0.78	0.62
	$\leq 960^{4)}$	≤ 50	4.30	550	4.30	2.14	1.39	1.01
	$\leq 1,000$	≤ 50	0.55	661	2.52	1.60	1.21	0.99
		≤ 50	0.50	592	2.41	1.65	1.31	1.11

FUS 62/2.5 (picture 4)		MLAR - loads			Max. Loads			
Vertical FUS 41/2.5		strain	F-resistance	Max. strain	Fire resistance time [minute]			
Load case	l_s	$\min a^{1)}$	30	$\min a^{2)}$	30	60	90	120
	[mm]	[mm]	[kN]	[mm]	[kN]	[kN]	[kN]	[kN]
Point load	$\leq 1,000$	≤ 50	0.57	369	1.33	0.87	0.68	0.57
multiple load ³⁾	$\leq 1,000$	≤ 50	0.62	649	1.92	1.34	1.08	0.92
Uniformly distributed load	$\leq 1,000$	≤ 50	0.62	649	1.92	1.34	1.08	0.92

The following figures are valid for FUS channels and FCA cantilever arms, galvanized, hdg and stainless steel.

- 1) Valid for a suspension height $h_a \leq 500$ mm
- 2) Based on suspension height $h_a = 250$ mm, Expansion length of threaded rods in case of fire ~ 10 mm/m
- 3) Given load values apply for multiple loads as summated point loads symmetrical allocated.
- 4) This values are valid for FCA 62/2.5 with additional support by threaded rod.

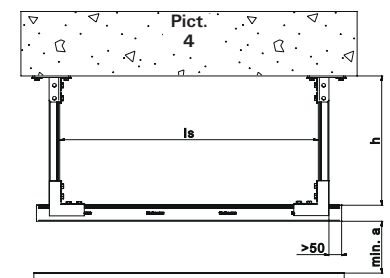
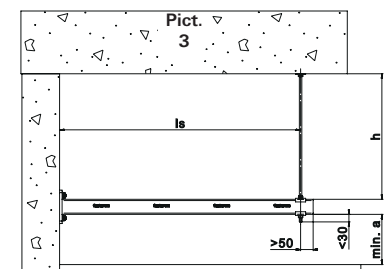
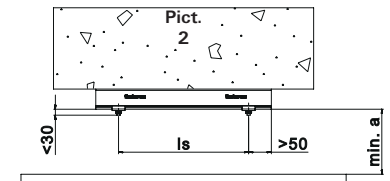
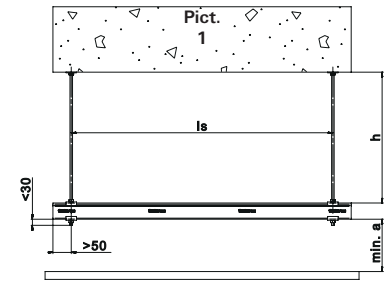

APPLICATION POSSIBILITIES

Point load =

Spot load, e.g. a pipe clamp on the rail.

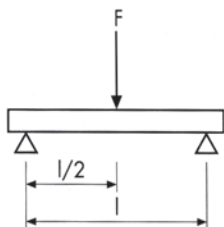

Multiple load =

More than one load point on the rail, e.g. several pipe clamps.

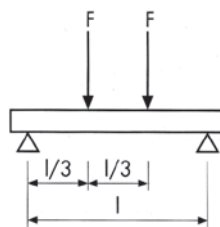

Uniformly distributed load =

Uniform distribution of load on the rails, e.g. bend-proof ventilation duct.

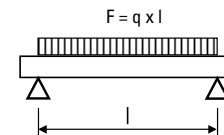

Fire tests of fasteners and anchors in concrete

The fire tests on anchors and fasteners is carried out into C20/25 cracked and uncracked concrete or masonry, following the standard time/temperature curve (ETK) according to DIN 4102 or ISO 834.

The anchors and fasteners have pre defined load applied and are exposed to flames without insulation or protective measures. The fire resistance is indicated by the time the anchor or fastener resist without failure.

Additional ETKs can be adopted for special applications such as RABT ZTV tunnel curve.

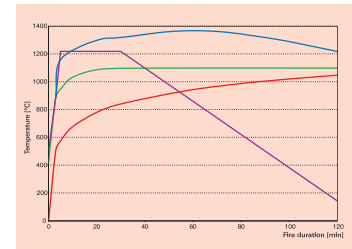

— (ETK), — Hydrocarbon curve, — RABT Tunnel curve, — Rijkswaterstaat Tunnel curve

TECHNICAL DATA



Zykron anchor **FZA**

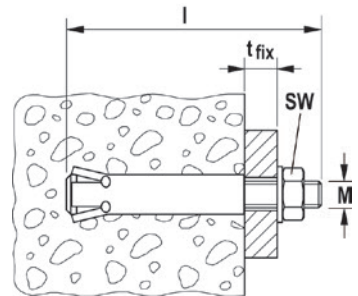

Item	Material			Permissible tensile load in case of a fire [kN]				Test report Approval no.	Certificate			Application
	gvz	A4	C	R30	R60	R90	R120		RWS	VdS	FM	
FZA M6	■			1.0	0.5	0.35	0.25	3277/0531-1 (of 28.02.2013) Text: 3091/2013				Cracked and non-cracked concrete
FZA M8	■			1.5	0.8	0.5	0.4			■		
FZA M10	■			4.5	2.2	1.3	0.9			■	■	
FZA M12	■			8.5	3.5	2.0	1.5			■	■	
FZA M16	■			13.5	6.5	4.0	3.0			■	■	
FZA M6 A4/C		■	■	2.1	1.2	0.85	0.7					
FZA M8 A4/C		■	■	10.0	4.0	1.8	1.0			■		
FZA M10 A4/C		■	■	18.0	7.0	3.5	2.0			■	■	
FZA M12 A4/C		■	■	22.0	9.0	5.0	3.5			■	■	
FZA M16 A4/C		■	■	24.0	12.0	7.5	6.0			■	■	

TECHNICAL DATA



Zykron anchor **FZA**

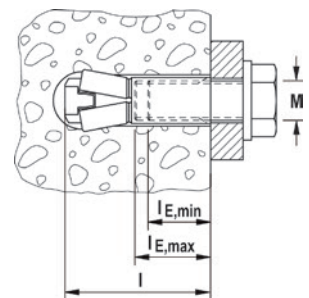

Item	Material			Permissible tensile load in case of a fire [kN]				Test report Approval no.	Certificate			Application
	gvz	A4	C	R30	R60	R90	R120		RWS	VdS	FM	
FZEA II 10x40 M8	■	■	■	1.0	0.9	0.8	0.7	ETA-06/0271		■		Cracked and non-cracked concrete
FZEA II 12x40 M10	■	■	■	1.8	1.8	1.6	1.2			■		
FZEA II 14x40 M12	■	■	■	1.8	1.8	1.8	1.5			■		

TECHNICAL DATA



Bolt anchor **FAZ II**

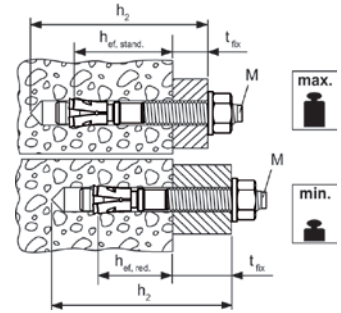

Item	Material			Permissible tensile load in case of a fire [kN]				Test report Approval no.	Certificate			Application
	gvz	A4	C	R30	R60	R90	R120		RWS	VdS	FM	
FAZ II M8/A4/C	■	■	■	1,4	1,2	0,9	0,8	ETA-05/0069		■		Cracked and non-cracked concrete
FAZ II M10/A4/C	■	■	■	2,8	2,3	1,9	1,6			■	■	
FAZ II M12/A4/C	■	■	■	5,0	4,1	3,2	2,8			■	■	
FAZ II M16/A4/C	■	■	■	7,1	7,1	6,0	5,2			■	■	

TECHNICAL DATA



High performance anchor **FH II-S** with hexagonal head



High performance anchor **FH II-SK** with countersunk head

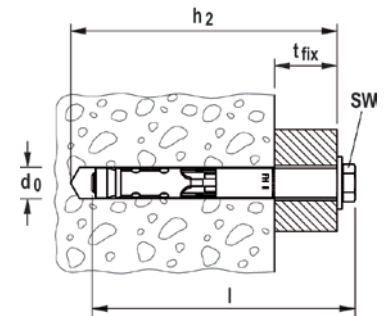

Item	Material			Permissible tensile load in case of a fire [kN]				Test report Approval no.	Certificate			Application
	gvz	A4	C	R30	R60	R90	R120		RWS	VdS	FM	
FH II 10 B/S/ H	■			0.2	0.2	0.1	0.1	ETA-07/0025		■		Cracked and non-cracked concrete
FH II 12 B/S/H/SK	■			2.0	1.3	0.6	0.2			■		
FH II 15 B/S/H/SK	■			3.2	2.3	1.4	1.0			■		
FH II 18 B/S/H	■			4.8	3.9	3.0	2.6			■		
FH II 24 B/S/H	■			8.9	7.3	5.6	4.8			■		

TECHNICAL DATA



Bolt anchor **FBN II**

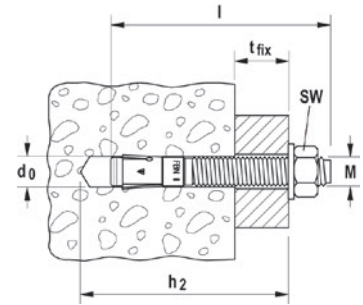

Item	Material			Permissible tensile load in case of a fire [kN]				Test report Approval no.	Certificate			Application
	gvz	A4	C	R30	R60	R90	R120		RWS	VdS	FM	
FBN II 8	■			1,4	1,1	0,7	0,6	PD III/B-07-444 <small>(of 29.11.2007)</small>				Non-cracked concrete
FBN II 10	■			4,2	3,1	2,0	1,4					
FBN II 12	■			9,5	6,8	4,2	2,8					
FBN II 16	■			17,7	12,7	7,8	5,3					
FBN II 20	■			27,6	19,9	12,2	8,4					

TECHNICAL DATA



Injection mortar **FIS V**



Injection mortar **FIS V**



Static mixer **FIS MR**

Item	Material			Permissible tensile load in case of a fire [kN]				Test report Approval no.	Certificate			Application
	gvz	A4	C	R30	R60	R90	R120		RWS	VdS	FM	
FIS A M8	■			1.9	0.8	0.3	0.15	3038/8141-3 <small>(of 10.01.2002)</small>				Non-cracked concrete
FIS A M10	■			4.5	2.1	1.0	0.6					
FIS A M12	■			8.5	3.6	2.1	1.5					
FIS A M16	■			13.5	6.4	4.0	3.0					
FIS A M20	■			21.0	10.0	6.0	4.5					
FIS A M24	■			30.0	14.0	9.0	6.5					
FIS A M30	■			45.0	22.0	14.0	10.0					
FIS A M8 A4/C		■	■	4.3	0.8	0.3	0.15					
FIS A M10 A4/C		■	■	7.5	2.1	1.0	0.6					
FIS A M12 A4/C		■	■	11.0	5.7	3.9	3.0					
FIS A M16 A4/C		■	■	25.0	10.0	5.8	4.0					
FIS A M20 A4/C		■	■	32.0	15.0	9.0	6.0					
FIS A M24 A4/C		■	■	45.0	22.0	13.0	9.0					
FIS A M30 A4/C		■	■	70.0	35.0	20.0	14.0					

TECHNICAL DATA



Hollow-ceiling anchor **FHY**

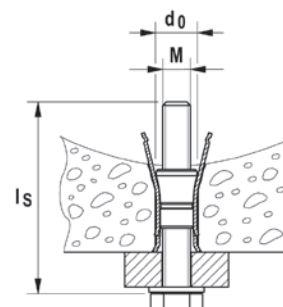

Item	Material			Permissible tensile load in case of a fire [kN]				Test report Approval no.	Certificate			Application
	gvz	A4	C	R30	R60	R90	R120		RWS	VdS	FM	
FHY M6	■			0.9	0.45	0.28	0.2	3566/3321 <small>(ref 21.06.2002)</small>				Prestressed concrete and hollow plate ceilings min. C45/55
FHY M8	■			0.9	0.9	0.75	0.6					
FHY M10	■			1.2	1.2	1.2	1.1					

TECHNICAL DATA

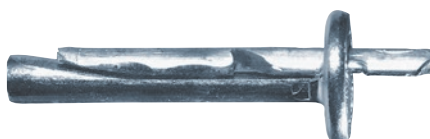

Ceiling nail **FDN**

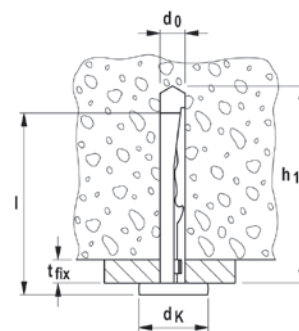

Item	Material			Permissible tensile load in case of a fire [kN]				Test report Approval no.	Certificate			Application
	gvz	A4	C	R30	R60	R90	R120		RWS	VdS	FM	
FDN 6/35	■			0.8	0.7	0.6	0.4	ETA-07/0144				Suspended ceilings
FDN 6/65	■			0.8	0.7	0.6	0.4					

TECHNICAL DATA



Nail anchor **FNA II** with nail head

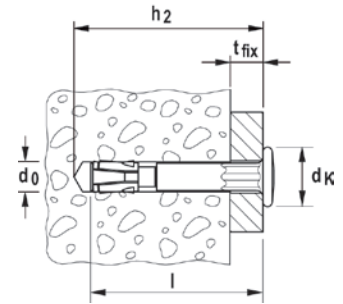

Item	Material			Permissible tensile load in case of a fire [kN]				Test report Approval no.	Certificate			Application
	gvz	A4	C	R30	R60	R90	R120		RWS	VdS	FM	
FNA II 6x25	■			0.6	0.61	0.5	0.3	ETA-06/0175				Manifold fixing of non-load-bearing systems
FNA II 6x25 M6	■			0.6	0.35	0.3	0.3		■			
FNA II 6x25 M8	■			0.6	0.35	0.3	0.5					
FNA II 6x25 OE	■			0.3	0.2	0.2	0.1					
FNA II 6x30	■			0.9	0.8	0.5	0.3					
FNA II 6x30 M6	■	■	■	0.6	0.35	0.3	0.3					
FNA II 6x30 M8	■	■	■	0.6	0.35	0.3	0.3		■			

TECHNICAL DATA



Hammerset anchor **EA II**. Not suitable for diamond drilling appliances and diamond saws.

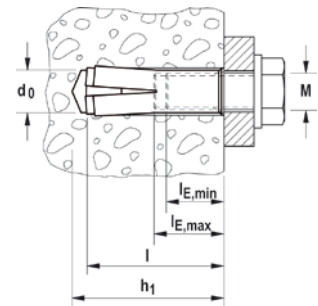

Item	Material			Permissible tensile load in case of a fire [kN]				Test report Approval no.	Certificate			Application
	gvz	A4	C	R30	R60	R90	R120		RWS	VdS	FM	
EA II M6 ³⁾	■	■	■	0,5	0,5	0,4	0,3	ETA-07-0142		●		Suspended ceilings and non-cracked concrete
EA II M8x40	■			1,3	0,9	0,6	0,5			●	●	
EA II M10x30	■			0,9	0,9	0,9	0,6			●	●	
EA II M12x25	■			0,6	0,6	0,6	0,5					

fischer metal insulation fixing - fire resistance classification - R120

TECHNICAL DATA



Insulation support metal **DHM**,
washer-ø 35 mm



Insulation retaining metal washer **DTM 80**,
washer-ø 80 mm, inside-ø 11 mm

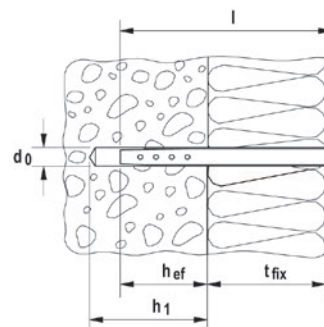

Item	Art.No.	Drill-Ø d_0 [mm]	Min. drill-hole depth t_d [mm]	Effect. anchorage depth h_{ef} [mm]	Anchor length l [mm]	Max. usable length t_{fix} [mm]	Qty. per box pcs.
DHM 30	088801	8	60	50	90	0 - 40	250
DHM 60	088802	8	60	50	110	30 - 60	250
DHM 90	088803	8	60	50	140	60 - 90	250
DHM 120	061581	8	60	50	170	90 - 120	250
DHM 135	503131	8	60	50	185	135	250
DHM 150	061582	8	60	50	200	120 - 150	250
DHM 30 INOX	506135	8	60	50	90	0 - 40	250
DHM 60 INOX	506136	8	60	50	110	30 - 60	250
DHM 90 INOX	506137	8	60	50	140	60 - 90	250
DHM 120 INOX	506138	8	60	50	170	90 - 120	250
DHM 150 INOX	506140	8	60	50	200	120 - 150	250
DHM 80	088806	-	-	-	-	-	250
DHM 80 INOX	506141	-	-	-	-	-	250

fischer fixings for drywall

TECHNICAL DATA



HM-S with metric screw



HM-SS with hexagon headed screw

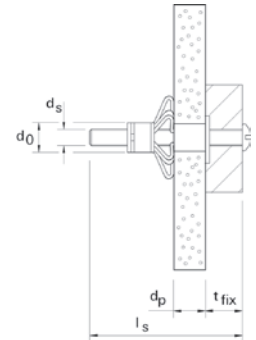

Item	Art.No.	Drill-Ø d_0 [mm]	Min. drill-hole depth t_d [mm]	Effect. anchorage depth h_{ef} [mm]	Anchor length l [mm]	Max. usable length t_{fix} [mm]	Qty. per box pcs.
HM 4 x 32 S	062306	8	42	32	M 4 x 40	0 - 40	3 - 13
HM 4 x 46 S	062307	8	56	46	M 4 x 53	30 - 60	5 - 18
HM 4 x 59 S	062308	8	69	59	M 4 x 66	60 - 90	35 - 42
HM 5 x 37 S	062310	10	47	37	M 5 x 45	90 - 120	6 - 15
HM 5 x 52 S	062311	10	62	52	M 5 x 60	135	7 - 21
HM 5 x 65 S	062312	10	75	65	M 5 x 73	120 - 150	20 - 34
HM 6 x 37 S	062314	12	47	37	M 6 x 45	0 - 40	6 - 15
HM 6 x 52 S	062315	12	62	52	M 6 x 60	30 - 60	10 - 21
HM 6 x 65 S	062328	12	75	65	M 6 x 70	60 - 90	20 - 34
HM 6 x 80 S	062316	12	90	80	M 6 x 88	90 - 120	38 - 50
HM 8 x 55 SS	062329	12	65	55	M 8 x 60	120 - 150	10 - 21

TECHNICAL DATA



Plasterboard fixing metal GKM

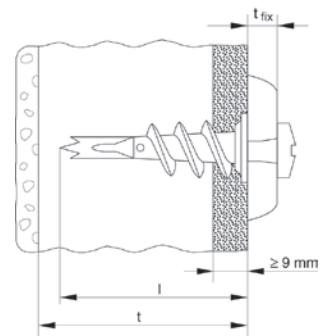

Item	Art.No.	Anchor length l [mm]	Min. thickness to first supporting layers [mm]	Max. usable length t_{fix} [mm]	Screw $d_s \times l_s$ [mm]	Qty. per box pcs.
GKM	024556	31	35	-	4 - 5	100
GKM 12	040432	31	35	12	4.5 x 35	100
GKM 27	040434	31	35	27	4.5 x 50	100

fischer bracket system

TECHNICAL DATA



Quick-fix strap

Item	Art.No.	Qty. per box pcs.	length [mm]	Profile	Profile thickness [mm]
Quick-fix strap 1 m	42975	10	1.000	3/50	3
Quick-fix strap 2 m	48179	10	2.000	3/50	3

TECHNICAL DATA



Quick-fix back plates

Item	Art.No.	Qty. per box pcs.	length [mm]	Profile	Profile thickness [mm]
Quick-fix back plates	42974	50	50 x 70	3/50	3

TECHNICAL DATA

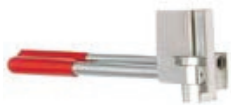

Quick fix pliers

Item	Art.No.	Qty. per box pcs.	length [mm]	Profile	Profile thickness [mm]
Quick-fix pliers	42974	1	-	-	-

Calculation for mastic/sealant

- a = Hole diameter in mm
- b = Depth of sealant in mm/wet film thickness for spray material (see recommendations)
- c = Pipe or bunched cables diameter in mm
- d = Annular space in mm (see recommendations)
- l = Length of square opening/joint
- w = Width of square opening/joint
- h = Cartridge or spray bucket size in ml
- n = Number of holes
- e = Area of hole in mm² = $\pi(a \div 2)^2$
- f = area of pipe in mm² = $\pi(a \div 2)^2$
- g = Amount of mastic needed per hole in ml = $((e-f) \times b) \div 1,000$

Round holes

No. of cartridges needed = $n \times (\frac{g}{h})$
 Area of hole e = $\pi \times (a \div 2)^2$ mm²
 Area of pipe f = $\pi \times (c \div 2)^2$ mm²
 Mastic volume = $g = ((e-f) \times b) \div 1,000$ ml

Example:

- a = 90 mm
- b = 40 mm
- c = 50 mm
- h = 310 ml
- n = 20

$$e = 3.14 \times 45^2 = 6,361.73 \text{ mm}^2$$

$$f = 3.14 \times 25^2 = 1,963.50 \text{ mm}^2$$

$$g = ((6,361.73 - 1,963.50) \times 40) \div 1,000 = 175.92 \text{ ml}$$

$$\text{No. of cartridges} = 20 \times (\frac{175.92}{310}) = 11.35 \text{ cartridges}$$

Square holes

No. of cartridges needed = $n \times (\frac{g}{h})$
 Area of hole e = l x w mm²
 Area of pipe f = $\pi \times (c \div 2)^2$ mm²
 Mastic volume = $g = ((e-f) \times b) \div 1,000$ ml

Example:

- l = 90 mm
- w = 100 mm
- b = 40 mm
- c = 50 mm
- h = 310 ml
- n = 20

$$e = 90 \times 100 = 9,000 \text{ mm}^2$$

$$f = 3.14 \times 25^2 = 1,963.50 \text{ mm}^2$$

$$g = ((9,000 - 1,963.50) \times 40) \div 1,000 = 281.46 \text{ ml}$$

$$\text{No. of cartridges} = 20 \times (\frac{281.46}{310}) = 18.1 \text{ cartridges}$$

Linear joints

No. of cartridges/buckets = $(\frac{g}{h})$
 Area of joint e = l x w mm²
 Mastic volume = $g = ((e-f) \times b) \div 1,000$ ml
 = g

Example for mastic/sealant:

- w = 20 mm
- l = 30m = 30,000 mm b = 10 mm
- h = 310 ml

$$e = 20 \times 30,000 = 60,000 \text{ mm}^2$$

$$g = (60,000 \times 10) \div 1,000 = 6,000 \text{ ml}$$

$$\text{No. of cartridges} = (\frac{6,000}{310}) = 19.4 \text{ cartridges}$$

Example of joint Spray:

- w = 100 mm, w1 = 125 mm (with overspray)
- l = 300 m = 300,000 mm
- b = 1.5 mm
- h = 19 litres = 19,000 ml
- e = 125 x 300,000 = 37,500,000 mm²
- g = (37,500,000 x 1.5) ÷ 1,000 = 56,250 ml
- No. of buckets = $(\frac{56,250}{19,000}) = 2.96$ buckets

Calculations for FireStop Block FBB

- a = block length = 230 mm = 0.23 m
- b = block width = 130 mm = 0.13 m
- l = length of opening
- w = width of opening
- t = block thickness = 60 mm = 0.06 m
- c = % penetrant area

Area to be covered/filled by blocks = $l \times b \times (1-c/100) = A$

Fire rating up to 60 minutes

Fire rating up to 120 minutes

No. of blocks required

$$\frac{A}{a \times t}$$

$$\frac{A}{b \times t}$$

Example:

l = 500 mm = 0.5 m

w = 500 mm = 0.5 m

c = 30%

Area to be covered/filled by blocks = $0.5 \times 0.5 \times (1 - 0.3) = 0.175 \text{ m}^2$

No. of blocks required

$$\frac{\text{Fire rating up to 60 minutes}}{0.175} = \frac{0.175}{(0.23 \times 0.06)} = 12.68$$

$$\frac{\text{Fire rating up to 120 minutes}}{0.175} = \frac{0.175}{(0.13 \times 0.06)} = 22.4$$

Calculation for compound

l = length of the opening

b = width of the opening

d = depth as per required fire rating

C = penetrant area or cross sectional area of services

Y = coverage/yield of 1 bag in litres

Volume of compound required = volume of opening - volume of services

$$= [(l \times b \times d) - (C \times d)] \text{ m}^3$$

$$= [(l \times b \times d) - (C \times d)] \times 1,000 \text{ litres}$$

$$= V$$

$$= \frac{V}{Y}$$

Example

l = 1,000 mm = 1 m

b = 500 mm = 0.5 m

d = 100 mm = 0.1 m

C = 20 % of opening = l x b x 20 % = 1 x 0.5 x 0.2 = 0.1

Y = 24 litres per 22 kg bag

Volume of compound required = $[(1 \times 0.5 \times 0.1) - (0.1 \times 0.1)] \times 1,000$ litres

V = 40 litres

$$\text{Numbers of bags required} = \frac{40}{24} = 1.67 \text{ bags}$$

Calculation for FIP

Estimation of large and medium size pillows in walls and floors openings of size up to 1 sq. meter.

Width [mm]	Size Seal type	Length [mm]											
		Large 100	Medium 100	Large 300	Medium 300	Large 500	Medium 500	Large 700	Medium 700	Large 900	Medium 900	Large 1,000	Medium 1,000
200	Wall	3	5	7	13	12	22	17	31	21	39	24	47
	Floor	2	3	4	7	6	12	9	17	11	22	12	27
400	Wall	5	9	14	26	24	44	33	61	42	78	47	95
	Floor	3	5	7	15	12	24	17	34	22	43	24	52
600	Wall	7	13	21	39	35	65	49	91	63	117	70	143
	Floor	4	7	11	22	18	36	25	51	33	65	36	79
800	Wall	9	18	28	52	47	87	66	122	84	157	94	192
	Floor	5	10	15	29	24	48	34	67	33	87	48	107
1,000	Wall	10	22	35	65	59	109	82	152	105	196	117	217
	Floor	6	12	18	36	30	60	42	84	54	108	60	120

Calculation for FBS

Material use as reference value for 40 % degree of seal use - number of cartridges for seal thickness 200 mm and 100 mm for 90 minutes and 30 minutes fire rating respectively.

Seal surface m ²	Volume @ 200 mm depth [m ³]	Cartridge 180 g	Volume @ 100 mm depth [m ³]	Cartridge 180 g	Core boring [mm]	Volume @ 200 mm depth [m ³]	Cartridge 180 g	Volume @ 200 mm depth [m ³]	Cartridge 180 g
0.005	0.001	0.92	0.0005	0.48	50	0.0004	0.36	0.0002	0.18
0.01	0.002	1.85	0.001	0.98	60	0.0006	0.52	0.0003	0.26
0.02	0.004	3.69	0.002	1.85	70	0.0008	0.71	0.0004	0.36
0.03	0.006	5.54	0.003	2.77	80	0.001	0.93	0.0005	0.47
0.04	0.008	7.38	0.004	3.69	100	0.0016	1.45	0.0008	0.73
0.048	0.0096	8.92	0.0048	4.46	120	0.0023	2.09	0.0011	1.05
0.0625	-	-	0.0063	5.81	160	0.004	3.71	0.002	1.85
					200	0.0062	5.8	0.0031	2.9

* The above calculations do not consider wastage of material. Please consider an appropriate factor.

fischer Training

Fire protection seminars with certificate for professionals.

Show your competence.
Become a trusted specialist of your work!

- Do the right thing quickly and safely
- Competently assess legal issues and resolve them

We will show you the options for the individual systems, tips and tricks for handling, and give you a clear, competitive advantage.

We will bring you and your employees up-to-speed in preventative fire protection.

- Basic introduction to fire protection
- Model building codes
- Fire testing standards
- Product selection criteria
- Trade and a Application areas
- Practical installations

Locations and dates

Please contact your fischer representative for further details on course dates.

The entire range of **knowledge** is shared with you **by fischer** fire protection experts.

CERTIFICATE

We hereby certify that

.....

has successfully demonstrated a level of competence in:

**“The correct installation of
fischer *FireStop* products”**

FCPS Coated Panel & FIAM Acoustic Mastic - FiPW Pipe Wrap -
FFC Collar - FFRS Silicone Sealant
FFFC Compound - FiP Pillow - PBB Firestop Block - FBS Graphite Foam

And agrees to adhere to the fischer Firestop Professional Ethics (FFPE)

fischerwerke Academy
01th Feb 2017

FIRE STOP

IZE/2012/FS/001

Constantin Wiegert
Product Manager
FireStop

fischerwerke GmbH & Co. KG
Klaus-fischer-Str. 1
72178 Waldachtal
Deutschland

*This certificate is valid for one year from the date of issue.

Project name: _____ Requested by: _____
 Consultant: _____ Company: _____
 Contactor: _____ Email: _____
 Contact: _____ Phone: _____
 Email: _____ Fax: _____
 Phone: _____ Supplier: _____
 Fax: _____ fischer engineer: _____

Fire rating requirements

Frating (hours): _____ Trating (hours): _____ Approval type: _____

Through penetration

Assembly details: Wall Floor
 Base material: Concrete Blocks Drywall
 Thickness: _____
 Other please specify: _____
 Opening details: Circular Rectangular Sleved Yes No Size _____
 Sleeve type PVC Steel
 Annular Space: Min: _____ Max: _____
 Penetration details: Pipe Duct Cables Cable trays/ladders Bus Bars
 Size _____ Size _____ Size _____ Size _____ Size _____
 Type _____ Type _____ Type _____ Type _____ Type _____
 Insulation _____ Insulation _____ Insulation _____ Insulation _____ Insulation _____
 Type _____ Type _____ Type _____ Type _____ Type _____
 Thick _____ Thick _____ % fill _____ Nos _____

Joint

Joint type: Head of wall Bottom of wall Floor to floor Floor to wall
 Wall to wall Perimeter joint
 Base material: Concrete Blocks Concrete Blocks
 Drywall Steeldeck Drywall Steeldeck
 Joint details: Static Dynamic Width _____
 Movement required: _____
 Curtain wall details: _____

Special conditions/comments/drawings/standards

The information in this catalogue is non-binding. Our technical service department can provide you with additional information and advice. However you will need to provide an accurate description of your particular application.

All information in this catalogue must be adjusted to local conditions and materials used. If individual items and types are not listed with detailed performance specifications, please contact your local fischer representative for further consultation.

Subject to errors, technical and product line changes, liability for printing errors and omissions is excluded.

Product details are correct at time sent to print.



Contacts

fischerwerke GmbH & Co. KG
Klaus-Fischer-Straße 1
72178 Waldachtal
Germany

Phone: +49 7443 12-0
E-mail info@fischer.de
www.fischer.de

fischer fixings UK Ltd.
Whitely Road
Oxon OX10 9AT Wallingford
Great Britain

Phone: +44 1491 827900
Fax: +44 1491 827953
E-mail info@fischer.co.uk
www.fischer.co.uk

fischer Systems Asia Pte. Ltd.
150 Kampong Ampat
#04-03 KA Centre
Singapore 368324

Phone: +65 62 85 22 07
Fax: +65 62 85 83 10
E-mail sales@fischer.sg

Your dealer



536316 (4) · 06/2019 · V-MKS/EL · Printed in Germany

